

Product Summary

$V_{(BR)DSS}$	$R_{DS(on)MAX}$	I_D
40V	6.8mΩ@10V	60A

Feature

- Split gate trench MOSFET technology
- Excellent package for heat dissipation
- High density cell design for low $R_{DS(ON)}$

Application

- DC-DC converter
- Power switching application
- Uninterruptible power supply

Package

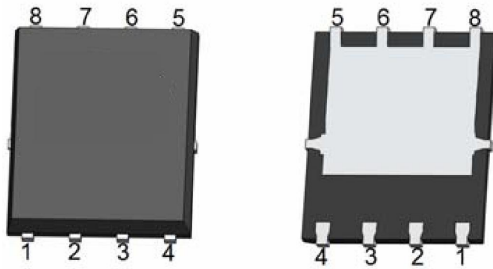

PDFN5*6-8L

Circuit diagram

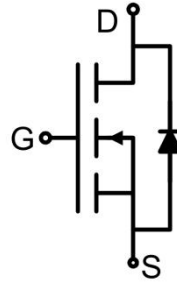

Marking

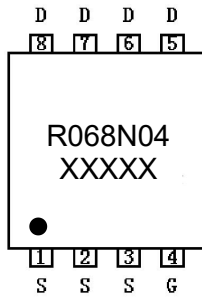

Absolute maximum ratings ($T_A=25^\circ\text{C}$ unless otherwise noted)

Parameter	Symbol	Value	Unit
Drain-Source Voltage	V_{DS}	40	V
Gate-Source Voltage	V_{GS}	± 20	V
Continuous Drain Current ($T_C=25^\circ\text{C}$)	I_D	60	A
Continuous Drain Current ($T_C=100^\circ\text{C}$)	$I_D(100^\circ\text{C})$	42	A
Pulsed Drain Current ¹⁾	I_{DM}	240	A
Power Dissipation ($T_C=25^\circ\text{C}$) ³⁾	P_D	75	W
Thermal Resistance, Junction-to-Ambient ⁴⁾	$R_{\theta JA}$	55	$^\circ\text{C}/\text{W}$
Thermal Resistance, Junction-to-Case	$R_{\theta JC}$	2	$^\circ\text{C}/\text{W}$
Single pulse avalanche energy ²⁾	E_{AS}	84.5	mJ
Junction Temperature	T_J	175	$^\circ\text{C}$
Storage Temperature	T_{STG}	-55 ~ +175	$^\circ\text{C}$

Electrical characteristics ($T_J=25^\circ\text{C}$, unless otherwise noted)

Parameter	Symbol	Test Condition	Min.	Typ.	Max.	Unit
Static Characteristics						
Drain-source breakdown voltage	$V_{(BR)DSS}$	$V_{GS} = 0V, I_D = 250\mu\text{A}$	40			V
Zero gate voltage drain current	I_{DSS}	$V_{DS} = 40V, V_{GS} = 0V$			1	μA
		$V_{DS} = 40V, V_{GS} = 0V, T_J = 175^\circ\text{C}$			100	
Gate-body leakage current	I_{GSS}	$V_{GS} = \pm 20V, V_{DS} = 0V$			± 100	nA
Gate threshold voltage	$V_{GS(th)}$	$V_{DS} = V_{GS}, I_D = 250\mu\text{A}$	2.0	3.0	4.0	V
Drain-source on-resistance	$R_{DS(on)}$	$V_{GS} = 10V, I_D = 20A$		5.2	6.8	m Ω
Dynamic characteristics⁵⁾						
Input Capacitance	C_{iss}	$V_{DS} = 20V, V_{GS} = 0V, f = 1\text{MHz}$		965		pF
Output Capacitance	C_{oss}			350		
Reverse Transfer Capacitance	C_{rss}			11		
Gate resistance	R_G	$f = 1.0\text{MHz}$		2		Ω
Total Gate Charge	Q_g	$V_{DS} = 20V, V_{GS} = 10V, I_D = 25A$		12.5		nC
Gate-Source Charge	Q_{gs}			4.6		
Gate-Drain Charge	Q_{gd}			2.9		
Turn-on delay time	$t_{d(on)}$	$V_{DD} = 20V, V_{GS} = 10V, I_D = 25A, R_{GEN} = 2.2\Omega$		9		nS
Turn-on rise time	t_r			127		
Turn-off delay time	$t_{d(off)}$			14		
Turn-off fall time	t_f			5		
Source-Drain Diode characteristics						
Diode Forward Current	I_S				60	A
Diode Forward voltage	V_{SD}	$V_{GS} = 0V, I_S = 20A$			1.2	V
Reverse Recovery Time	t_{rr}	$I_F = 25A, di/dt = 170A/\mu\text{s}$		17.5		nS
Reverse Recovery Charge	Q_{rr}				10	

Notes:

- 1) Repetitive rating; pulse width limited by max. junction temperature.
- 2) $T_J=25^\circ\text{C}$, $V_G=10V$, $R_G=25\Omega$, $L=1\text{mH}$, $I_{AS}=13A$.
- 3) P_d is based on max. junction temperature, using junction-case thermal resistance.
- 4) The value of $R_{\theta JA}$ is measured with the device mounted on 1in² FR-4 board with 2oz. Copper, in a still air environment with $T_A=25^\circ\text{C}$. The maximum allowed junction temperature of 150°C . The value in any given application depends on the user's specific board design.
- 5) Guaranteed by design, not subject to production testing.

Typical Characteristics

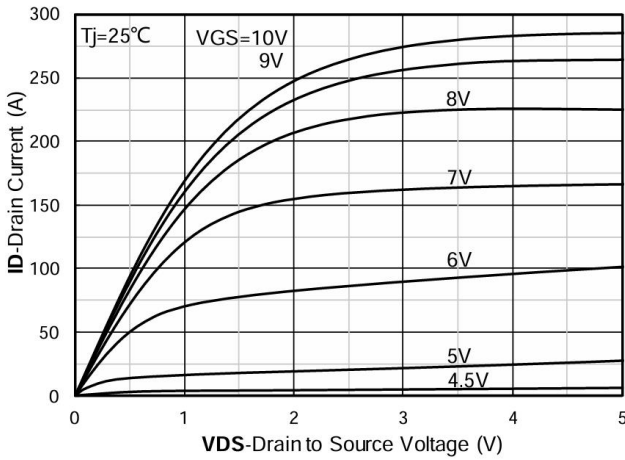

Figure 1. Output Characteristics

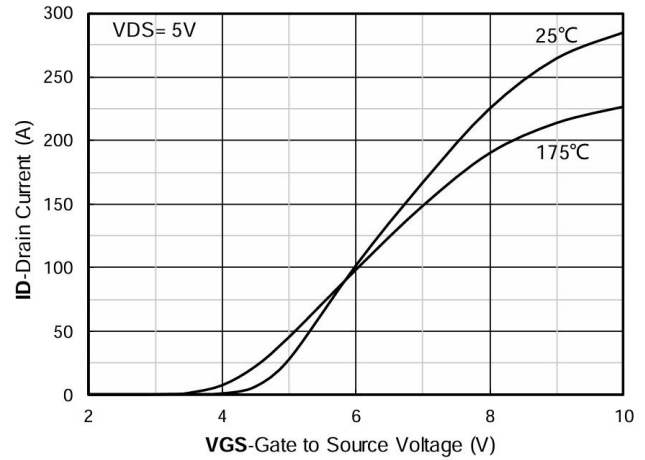

Figure 2. Transfer Characteristics

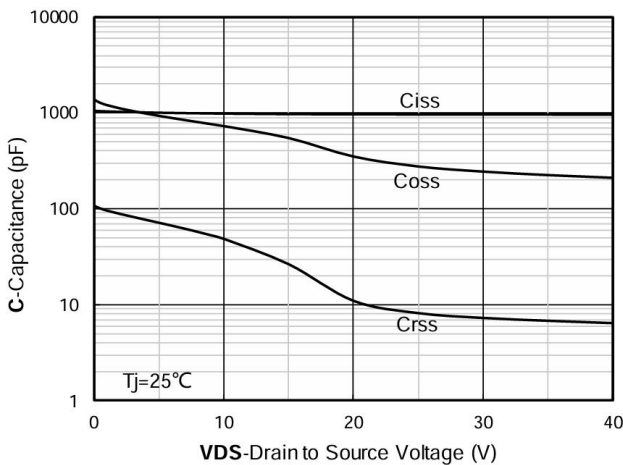

Figure 3. Capacitance Characteristics

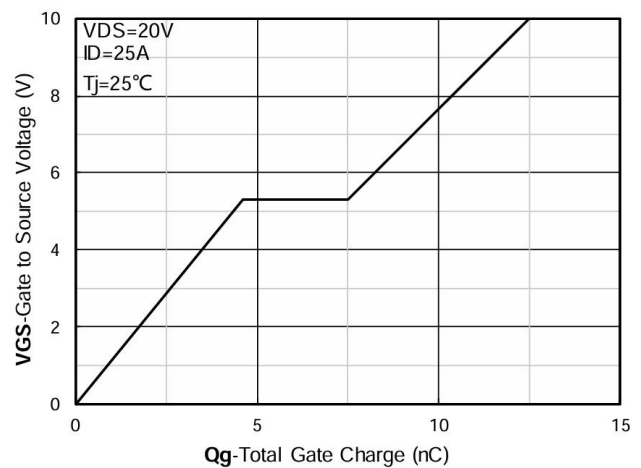

Figure 4. Gate Charge

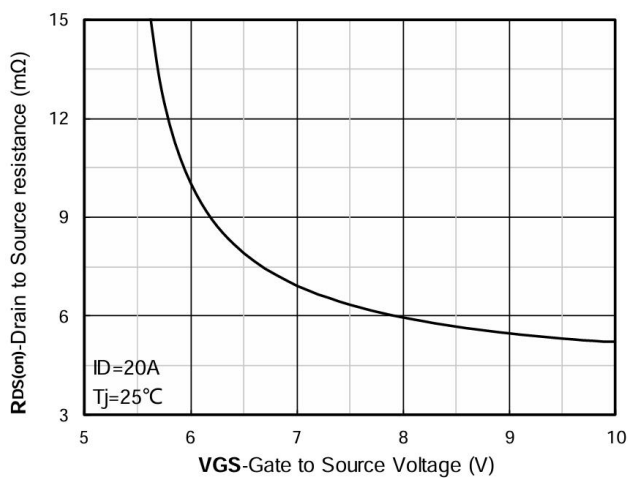

Figure 5. On-Resistance vs Gate to Source Voltage

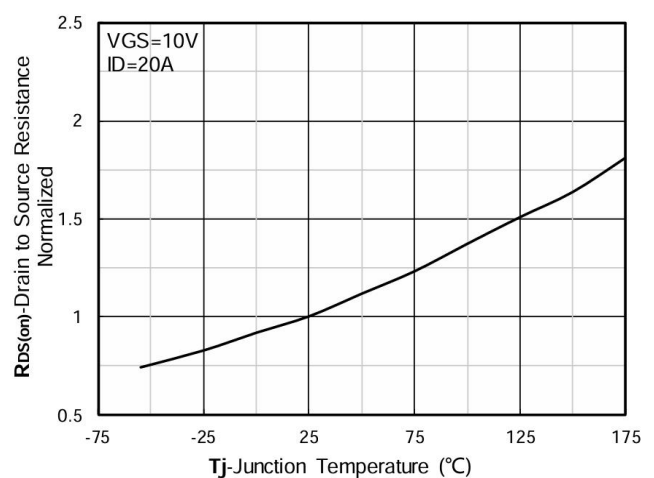

Figure 6. Normalized On-Resistance

Typical Characteristics

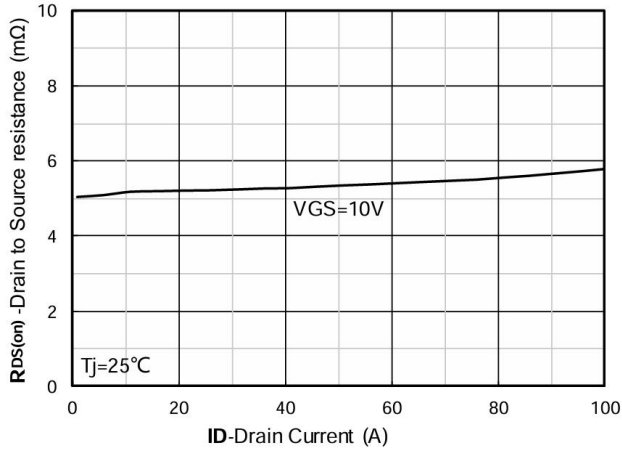

Figure 7. RDS(on) VS Drain Current

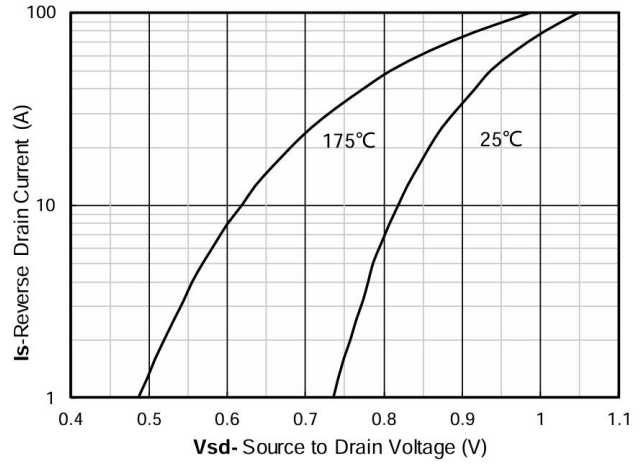

Figure 8. Forward characteristics of reverse diode

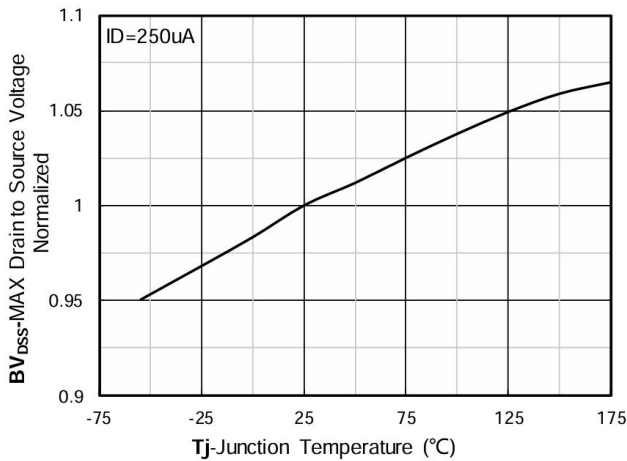

Figure 9. Normalized breakdown voltage

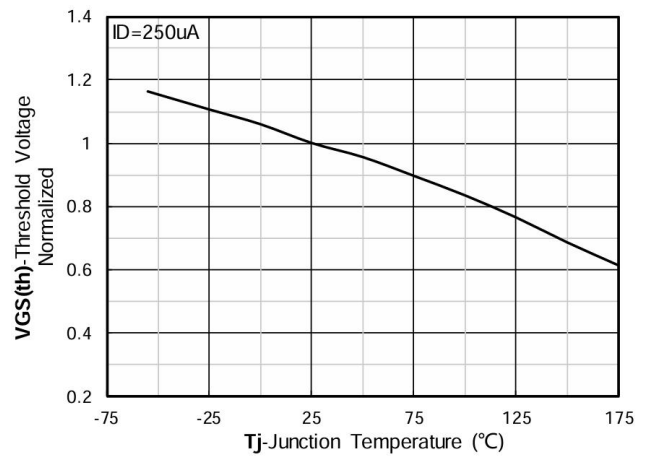

Figure 10. Normalized Threshold voltage

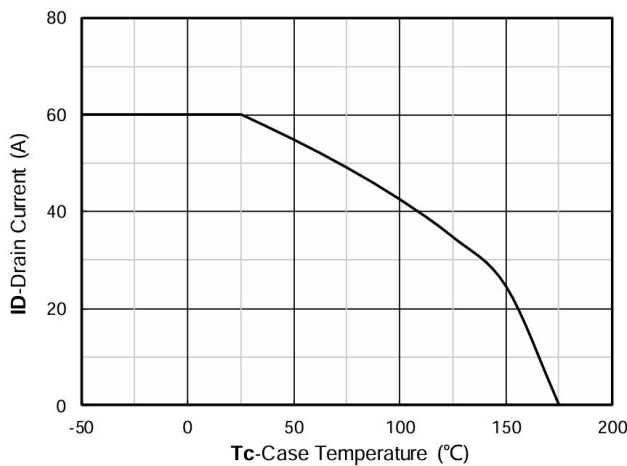

Figure 11. Current dissipation

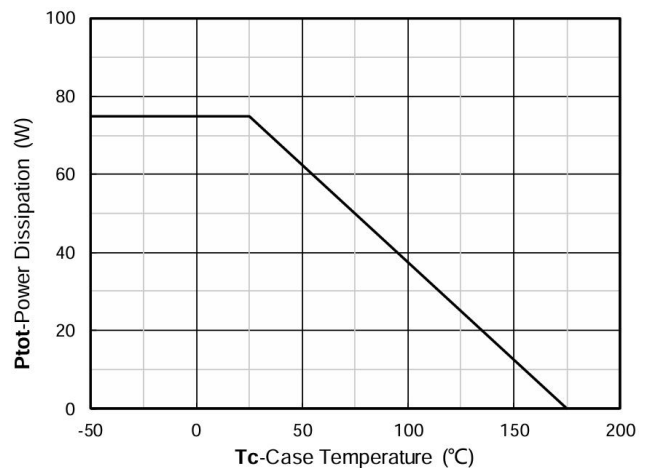

Figure 12. Power dissipation

Typical Characteristics

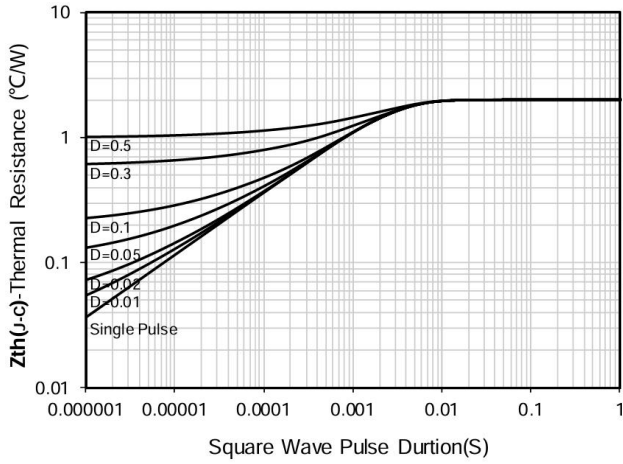

Figure 13. Maximum Transient Thermal Impedance

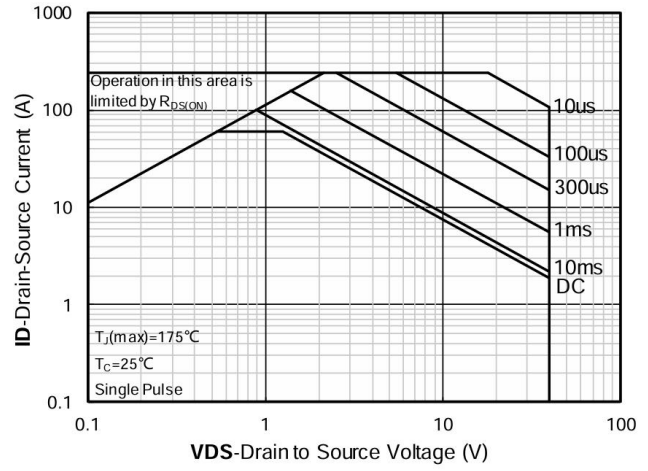
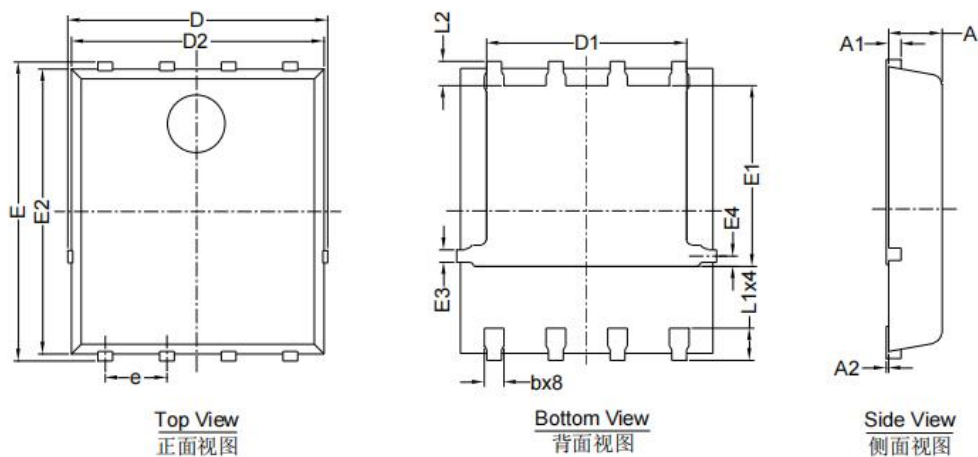

Figure 14. Safe Operation Area

PDFN5*6-8L Package Information



Symbol	Dimensions In Millimeters		Dimensions In Inches	
	Min.	Max.	Min.	Max.
D	5.150	5.550	0.203	0.219
E	5.950	6.350	0.234	0.250
A	1.000	1.200	0.039	0.047
A1	0.254 BSC		0.100 BSC	
A2	0.000	0.100	0.000	0.004
D1	3.920	4.320	0.154	0.170
E1	3.520	3.920	0.139	0.154
D2	5.000	5.400	0.197	0.213
E2	5.660	6.060	0.223	0.239
E3	0.254 REF		0.010 REF	
E4	0.210 REF		0.008 REF	
L1	0.560	0.760	0.022	0.030
L2	0.500 BSC		0.015 BSC	
b	0.310	0.510	0.012	0.020
e	1.270 BSC		0.050 BSC	