

### Product Summary

$V_{(BR)DSS}$	$R_{DS(on)MAX}$	$I_D$
60V	8.5mΩ@10V	50A
	11mΩ@4.5V	

### Feature

- Split Gate Trench MOSFET technology
- Excellent package for heat dissipation
- High density cell design for low  $R_{DS(ON)}$

### Application

- Power management functions
- Industrial and motor drive application
- DC-DC convertor

### Package

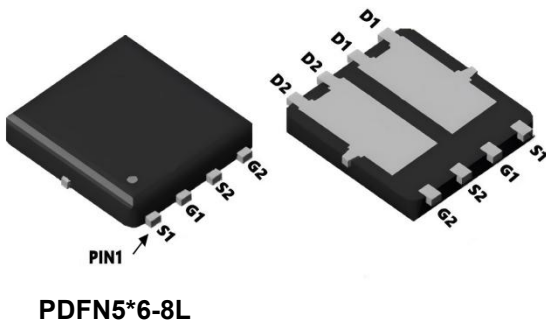

### Circuit diagram

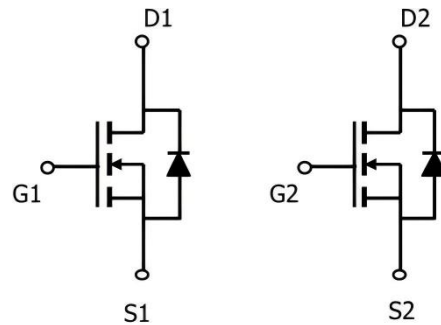

### Marking

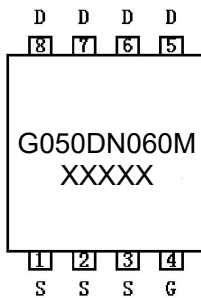

### Absolute maximum ratings (T<sub>A</sub>=25°C unless otherwise noted)

Parameter	Symbol	Value	Unit
Drain-Source Voltage	V <sub>DS</sub>	60	V
Gate-Source Voltage	V <sub>GS</sub>	±20	V
Continuous Drain Current(T <sub>C</sub> =25°C)	I <sub>D</sub>	50	A
Continuous Drain Current(T <sub>C</sub> =100°C)	I <sub>D</sub> (100°C)	31	A
Pulsed Drain Current <sup>1)</sup>	I <sub>DM</sub>	200	A
Single Pulse Avalanche Energy <sup>2)</sup>	E <sub>AS</sub>	162	mJ
Power Dissipation <sup>3)</sup> (T <sub>C</sub> =25°C)	P <sub>D</sub>	56	W
Thermal Resistance Junction to Case	R <sub>θJC</sub>	2.2	°C/W
Operating Junction Temperature	T <sub>J</sub>	-55 ~ +150	°C
Storage Temperature Range	T <sub>STG</sub>	-55 ~ +150	°C

### Electrical characteristics (T<sub>J</sub>=25 °C, unless otherwise noted)

Parameter	Symbol	Test Condition	Min.	Typ.	Max.	Unit
<b>Static Characteristics</b>						
Drain-source breakdown voltage	V <sub>(BR)DSS</sub>	V <sub>GS</sub> =0V, I <sub>D</sub> =250μA	60			V
Zero gate voltage drain current	I <sub>DSS</sub>	V <sub>DS</sub> =60V, V <sub>GS</sub> =0V			1	μA
Gate-body leakage current	I <sub>GSS</sub>	V <sub>DS</sub> =0V, V <sub>GS</sub> =±20V			±100	nA
Gate threshold voltage	V <sub>GS(th)</sub>	V <sub>DS</sub> =V <sub>GS</sub> , I <sub>D</sub> =250μA	1	1.8	2.5	V
Drain-source on-resistance	R <sub>DS(on)</sub>	V <sub>GS</sub> =10V, I <sub>D</sub> =20A		6.5	8.5	mΩ
		V <sub>GS</sub> =4.5V, I <sub>D</sub> =10A		8	11	
<b>Dynamic characteristics<sup>4)</sup></b>						
Input Capacitance	C <sub>iss</sub>	V <sub>DS</sub> =30V, V <sub>GS</sub> =0V, f =1MHz		1930		pF
Output Capacitance	C <sub>oss</sub>			400		
Reverse Transfer Capacitance	C <sub>rss</sub>			6		
Total Gate Charge	Q <sub>g</sub>	V <sub>DS</sub> =30V, V <sub>GS</sub> =10V, I <sub>D</sub> =25A		30.4		nC
Gate-Source Charge	Q <sub>gs</sub>			6.6		
Gate-Drain Charge	Q <sub>gd</sub>			5		
Turn-on delay time	t <sub>d(on)</sub>	V <sub>DS</sub> =30V, V <sub>GS</sub> =10V, I <sub>D</sub> =25A R <sub>G</sub> =2.2Ω		13.7		nS
Turn-on rise time	t <sub>r</sub>			62		
Turn-off delay time	t <sub>d(off)</sub>			25		
Turn-off fall time	t <sub>f</sub>			4.4		
<b>Source-Drain Diode characteristics</b>						
Diode Forward Current	I <sub>S</sub>				50	A
Diode Forward voltage	V <sub>SD</sub>	V <sub>GS</sub> =0V, I <sub>S</sub> =20A			1.2	V
Reverse Recovery Time	T <sub>rr</sub>	I <sub>F</sub> =25A, di/dt =-100A/μs		38		nS
Reverse Recovery Charge	Q <sub>rr</sub>			38		nC

Notes:

- 1) Repetitive rating; pulse width limited by max. junction temperature.
- 2) T<sub>J</sub>=25°C, V<sub>G</sub>=10V, R<sub>G</sub>=25Ω, L=1mH, I<sub>AS</sub>=18A.
- 3) P<sub>d</sub> is based on max. junction temperature, using junction-case and junction-ambient thermal resistance.
- 4) Guaranteed by design, not subject to production.

## Typical Characteristics

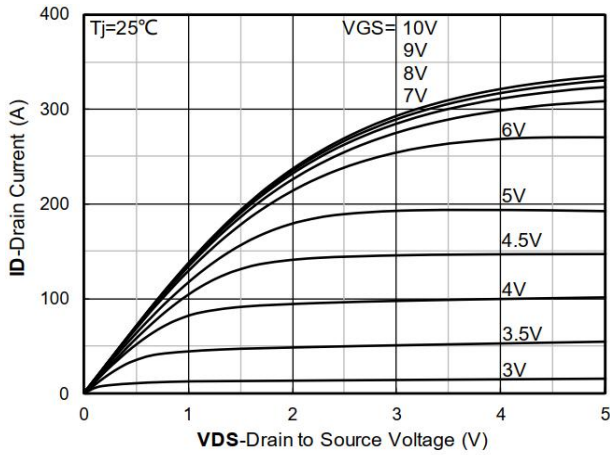

Figure 1. Output Characteristics

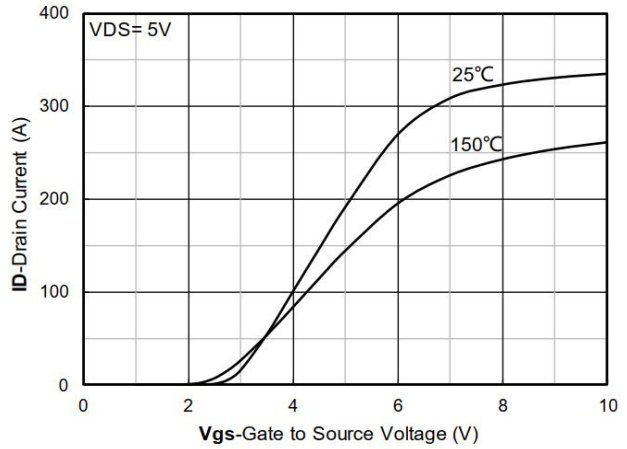

Figure 2. Transfer Characteristics

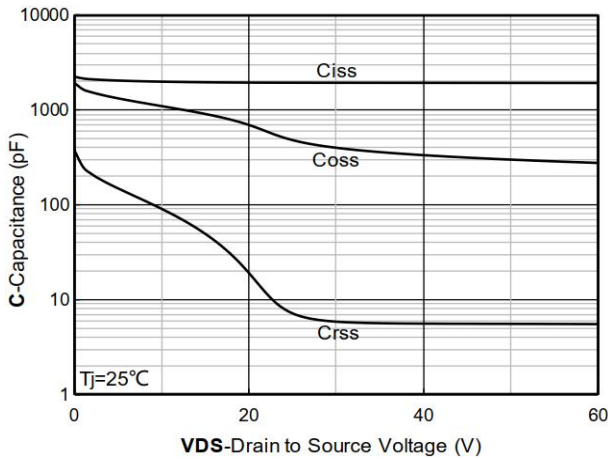

Figure 3. Capacitance Characteristics

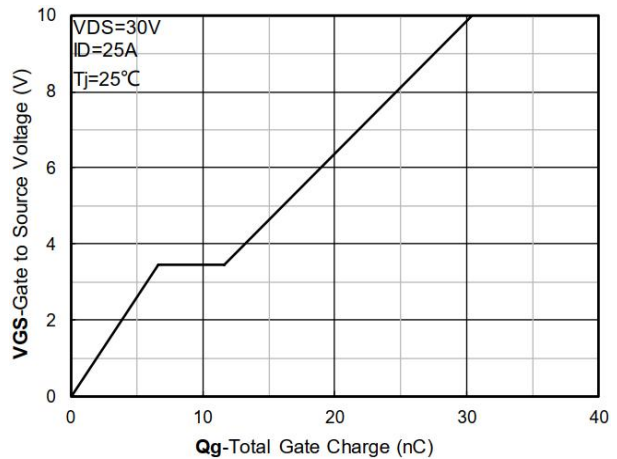

Figure 4. Gate Charge

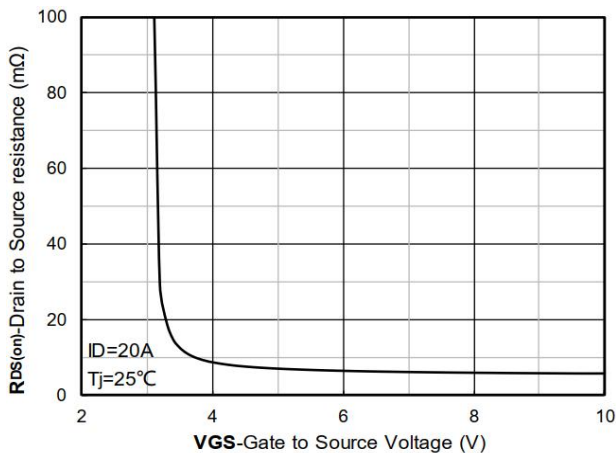

Figure 5. On-Resistance vs Gate to Source Voltage

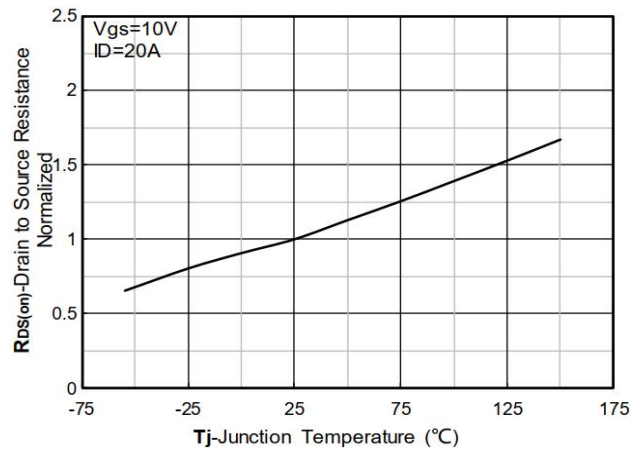

Figure 6. Normalized On-Resistance

## Typical Characteristics

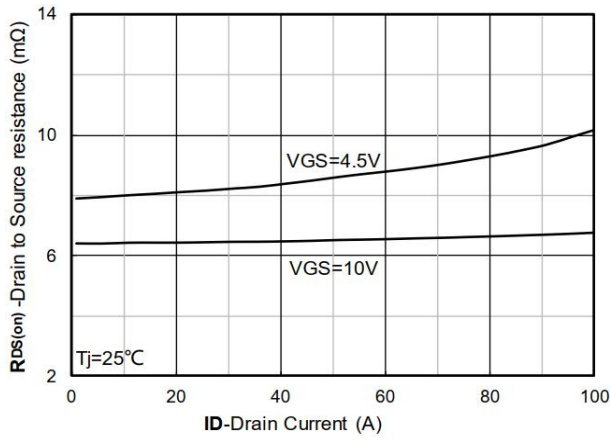

Figure 7.  $R_{DS(on)}$  VS Drain Current

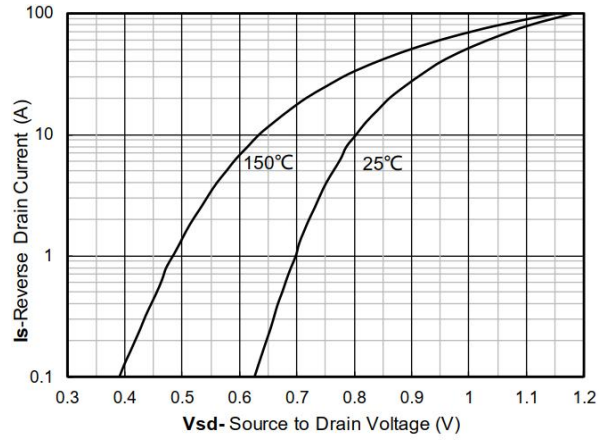

Figure 8. Forward characteristics of reverse diode

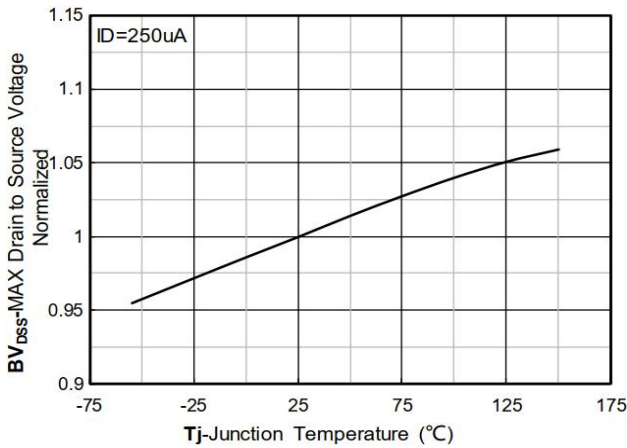

Figure 9. Normalized breakdown voltage

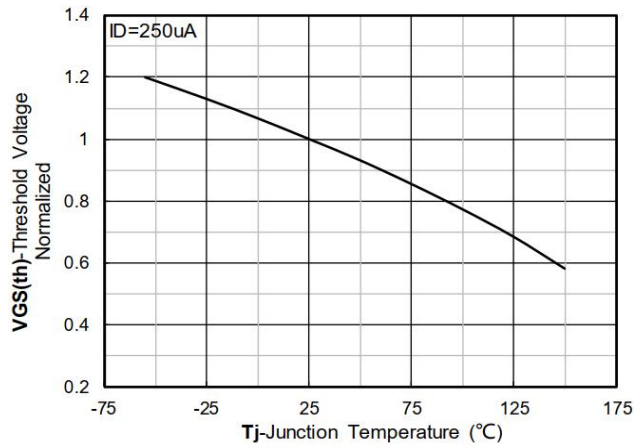

Figure 10. Normalized Threshold voltage

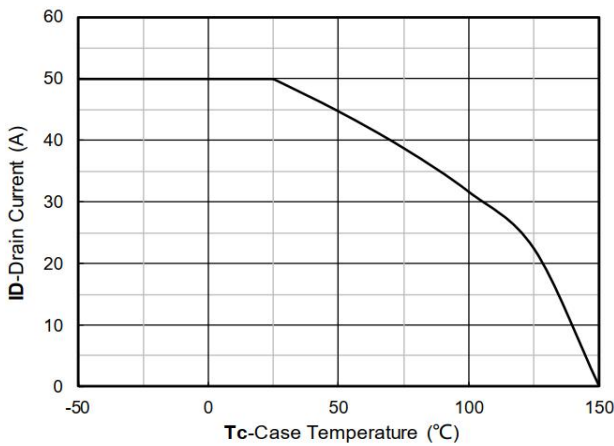

Figure 11. Current dissipation

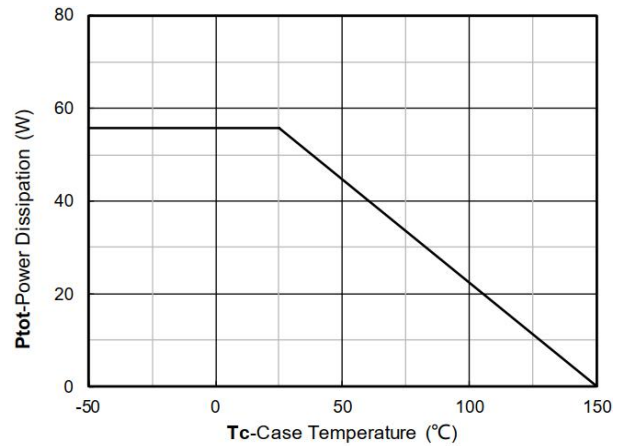

Figure 12. Power dissipation

## Typical Characteristics

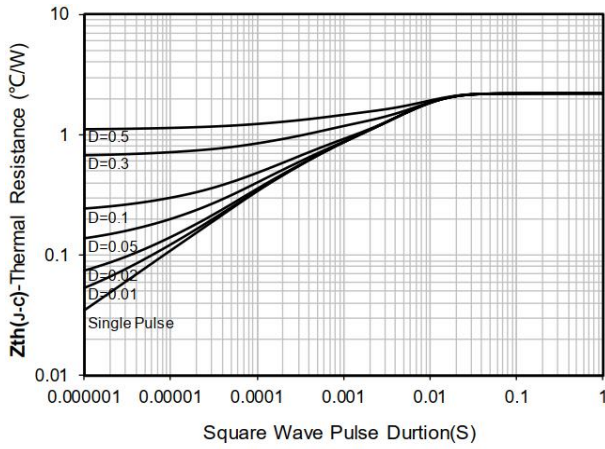

Figure 13. Maximum Transient Thermal Impedance

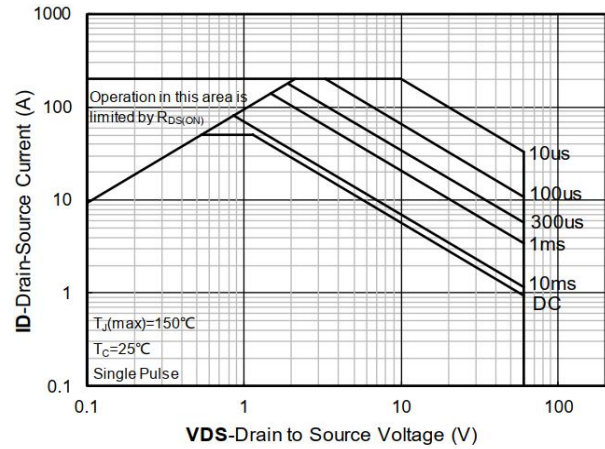
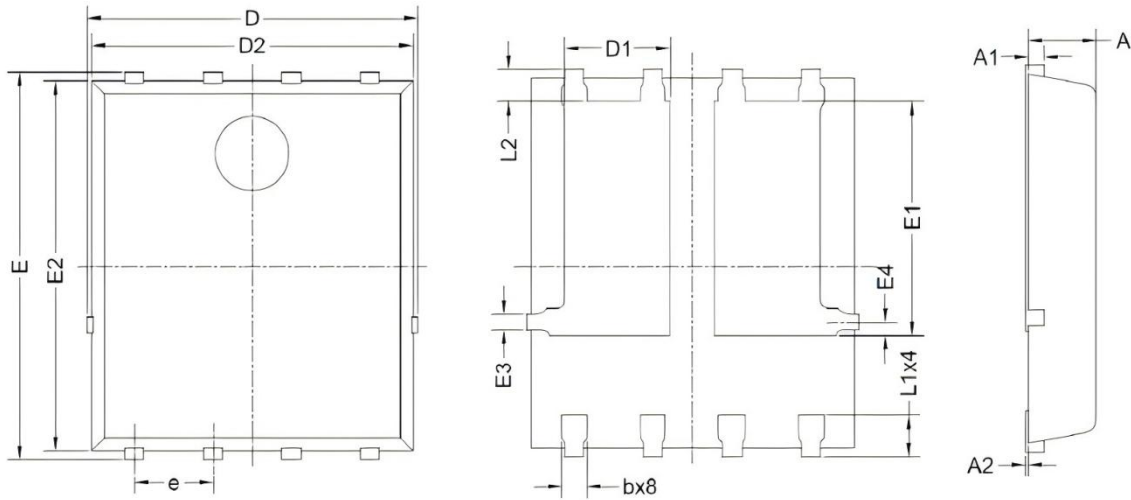

Figure 14. Safe Operation Area

### PDFN5\*6-8L Package Information



Symbol	Dimensions In Millimeters		Dimensions In Inches	
	Min.	Max.	Min.	Max.
D	5.150	5.550	0.203	0.219
E	5.950	6.350	0.234	0.250
A	1.000	1.200	0.039	0.047
A1	0.254 BSC.		0.010 BSC.	
A2	0.000	0.100	0.000	0.004
D1	1.500	1.900	0.059	0.075
E1	3.520	3.920	0.139	0.154
D2	5.000	5.400	0.197	0.213
E2	5.660	6.060	0.223	0.239
E3	0.254 REF.		0.010 REF.	
E4	0.210 REF.		0.008 REF.	
L1	0.560	0.760	0.022	0.030
L2	0.500 BSC.		0.020 BSC.	
b	0.310	0.510	0.012	0.020
e	1.270 BSC.		0.050 BSC.	