

Product Summary

$V_{(BR)DSS}$	$R_{DS(on)MAX}$	I_D
100V	7.5mΩ@10V	60A
	9.5mΩ@4.5V	

Feature

- Split gate trench MOSFET technology
- Excellent package for heat dissipation
- High density cell design for low $R_{DS(ON)}$

Application

- Power switching application
- Uninterruptible power supply
- DC-DC convertor

Package

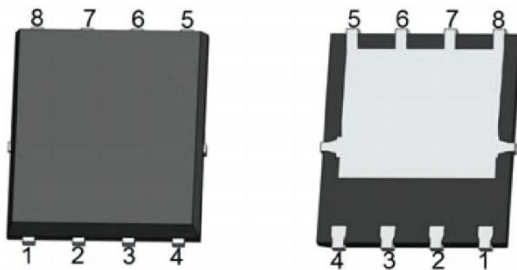

PDFN5*6-8L

Circuit diagram

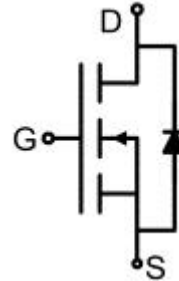

Marking

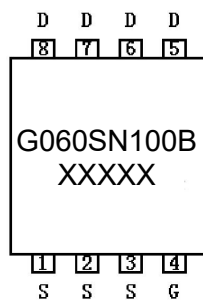

Absolute maximum ratings (T_A=25°C unless otherwise noted)

Parameter	Symbol	Value	Unit
Drain-Source Voltage	V _{DS}	100	V
Gate-Source Voltage	V _{GS}	±20	V
Continuous Drain Current (T _C =25°C)	I _D	60	A
Continuous Drain Current (T _C =100°C)	I _D (100°C)	37	A
Pulsed Drain Current ¹⁾	I _{DM}	240	A
Single Pulse Avalanche Energy ²⁾	E _{AS}	225	mJ
Power Dissipation ³⁾ (T _C =25°C)	P _D	89	W
Thermal Resistance Junction to Case	R _{θJC}	1.4	°C/W
Operating Junction Temperature	T _J	-55 ~ +150	°C
Storage Temperature	T _{STG}	-55 ~ +150	°C

Electrical characteristics (T_J=25 °C, unless otherwise noted)

Parameter	Symbol	Test Condition	Min.	Typ.	Max.	Unit
Static Characteristics						
Drain-source breakdown voltage	V _{(BR)DSS}	V _{GS} = 0V, I _D = 250μA	100			V
Zero gate voltage drain current	I _{DSS}	V _{DS} = 100V, V _{GS} = 0V			1	μA
Gate-body leakage current	I _{GSS}	V _{DS} = 0V, V _{GS} = ±20V			±100	nA
Gate threshold voltage	V _{GS(th)}	V _{DS} = V _{GS} , I _D = 250μA	1.3	1.9	2.5	V
Drain-source on-resistance	R _{DS(on)}	V _{GS} = 10V, I _D = 30A		6	7.5	mΩ
		V _{GS} = 4.5V, I _D = 20A		7.6	9.5	
Dynamic characteristics⁴⁾						
Input Capacitance	C _{iss}	V _{DS} = 50V, V _{GS} = 0V, f = 1MHz		2460		pF
Output Capacitance	C _{oss}			920		
Reverse Transfer Capacitance	C _{rss}			16		
Total Gate Charge	Q _g	V _{DS} = 50V, V _{GS} = 10V, I _D = 30A		39		nC
Gate-Source Charge	Q _{gs}			8		
Gate-Drain Charge	Q _{gd}			7		
Turn-on delay time	t _{d(on)}	V _{DS} = 50V, V _{GS} = 10V, I _D = 30A R _G = 2.2Ω		15		nS
Turn-on rise time	t _r			62		
Turn-off delay time	t _{d(off)}			27		
Turn-off fall time	t _f			5		
Source-Drain Diode characteristics						
Diode Forward Current	I _S				60	A
Diode Forward voltage	V _{SD}	V _{GS} = 0V, I _S = 30A			1.2	V
Reverse Recovery Time	T _{rr}	I _F = 30A, di/dt = -100A/μs		55		nS
Reverse Recovery Charge	Q _{rr}				87	

Notes:

- 1) Repetitive rating; pulse width limited by max. junction temperature.
- 2) T_J=25°C, V_{DD}=50V, V_G=10V, R_G=25Ω, L=2mH, I_{AS}=15A.
- 3) P_d is based on max. junction temperature, using junction-case thermal resistance.
- 4) Guaranteed by design, not subject to production testing.

Typical Characteristics

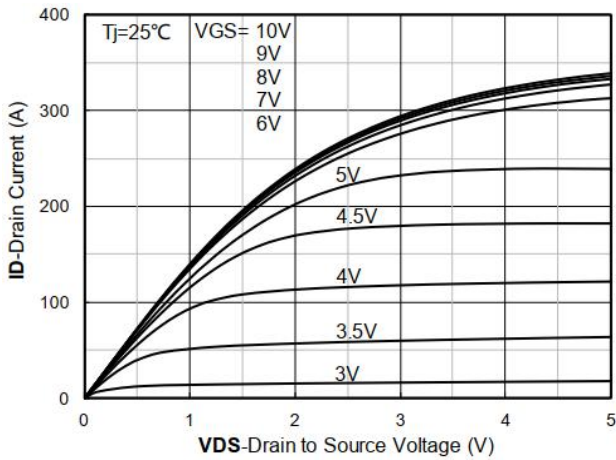

Figure 1. Output Characteristics

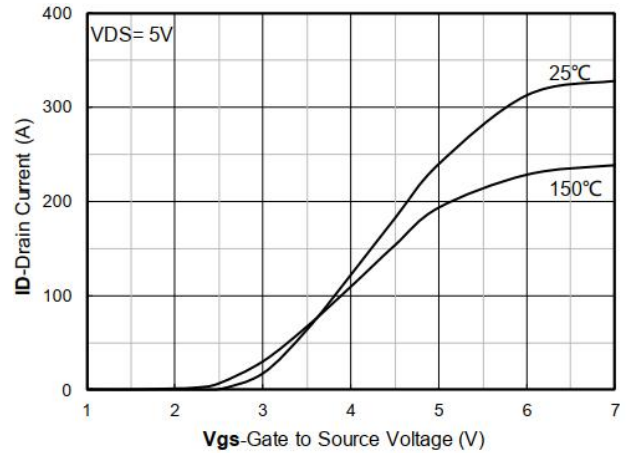

Figure 2. Transfer Characteristics

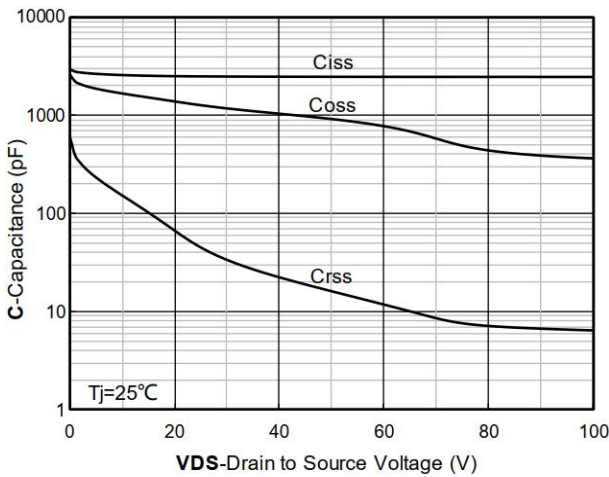

Figure 3. Capacitance Characteristics

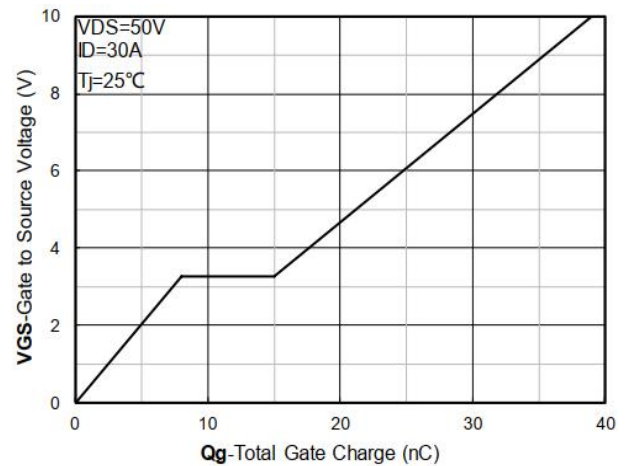

Figure 4. Gate Charge

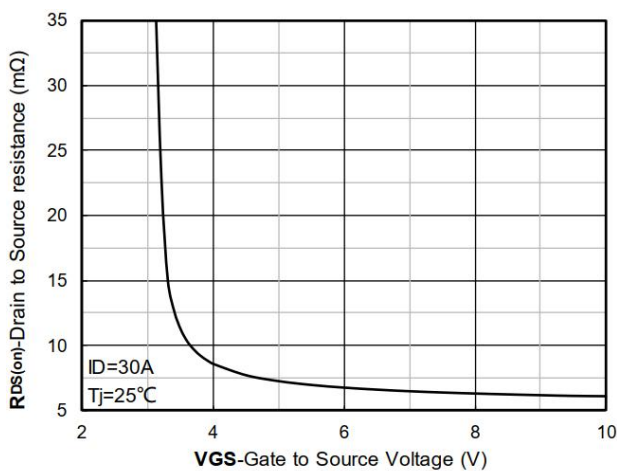

Figure 5. On-Resistance vs Gate to Source Voltage

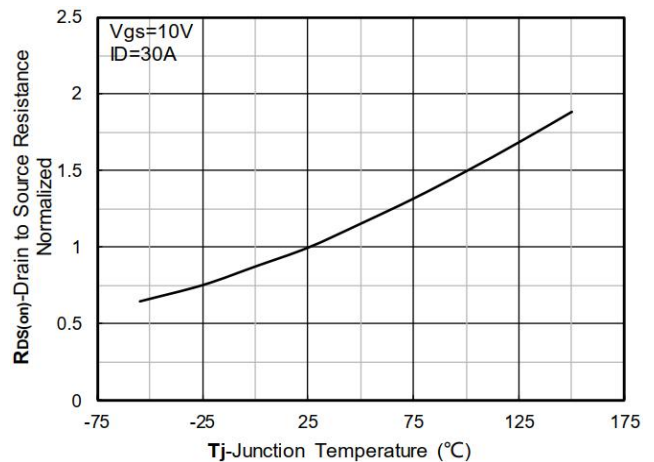

Figure 6. Normalized On-Resistance

Typical Characteristics

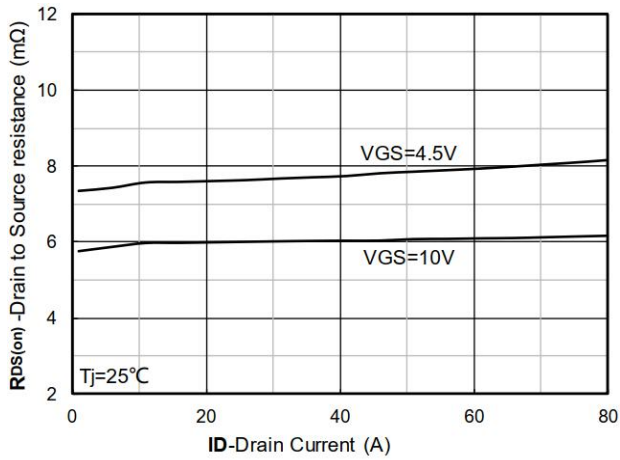

Figure 7. RDS(on) VS Drain Current

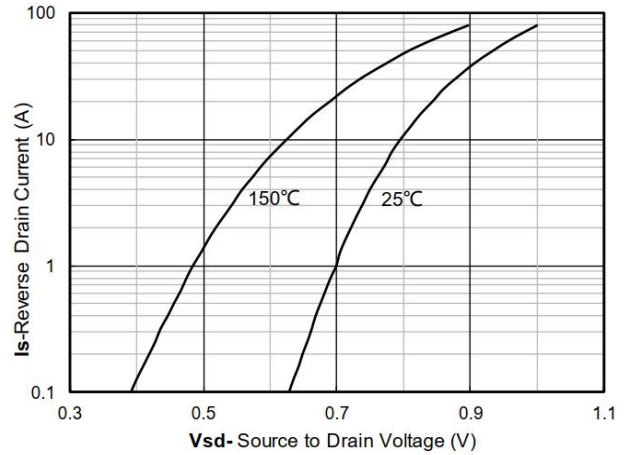

Figure 8. Forward characteristics of reverse diode

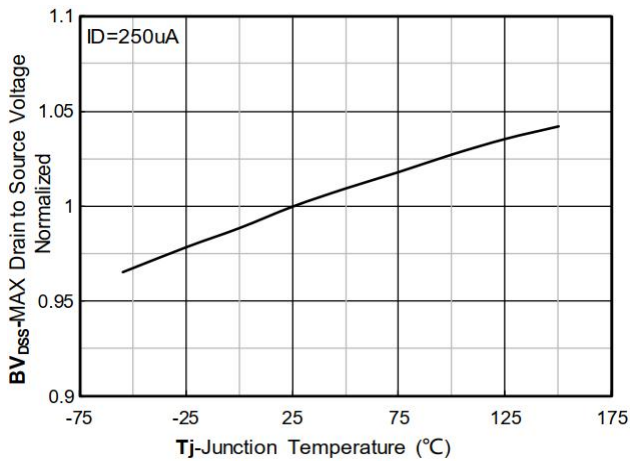

Figure 9. Normalized breakdown voltage

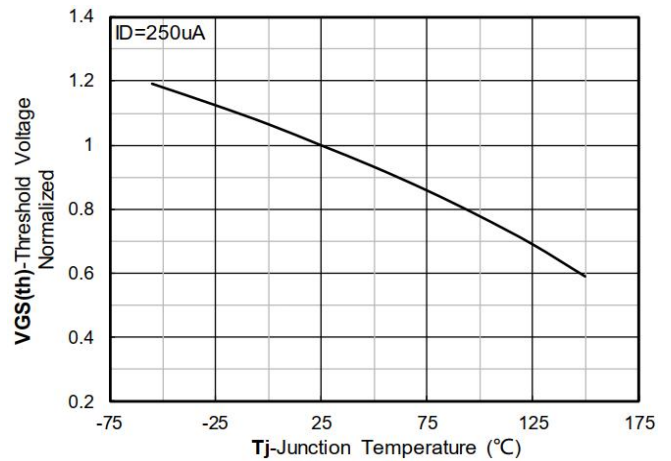

Figure 10. Normalized Threshold voltage

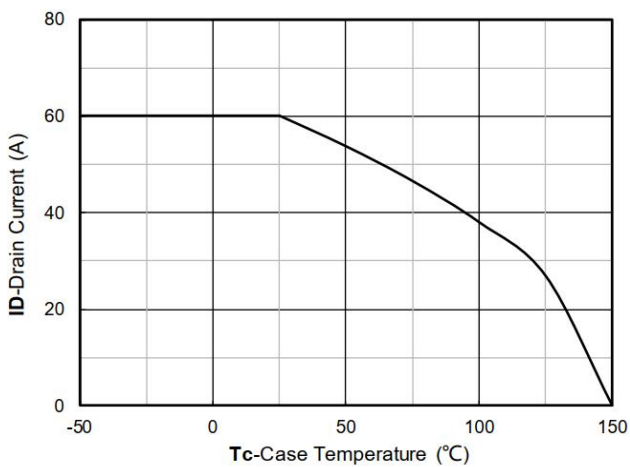

Figure 11. Current dissipation

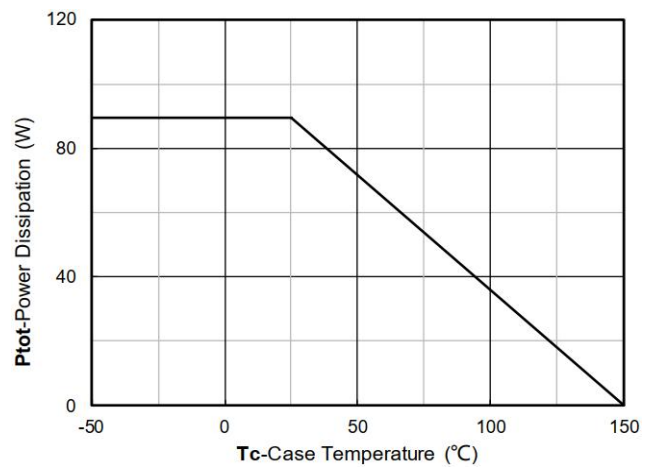

Figure 12. Power dissipation

Typical Characteristics

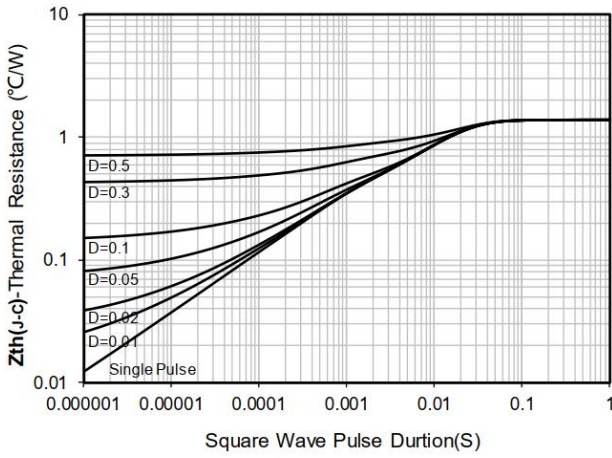

Figure 13. Maximum Transient Thermal Impedance

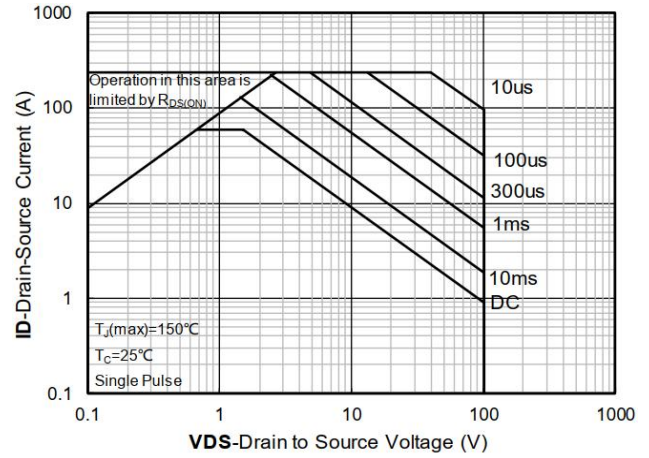
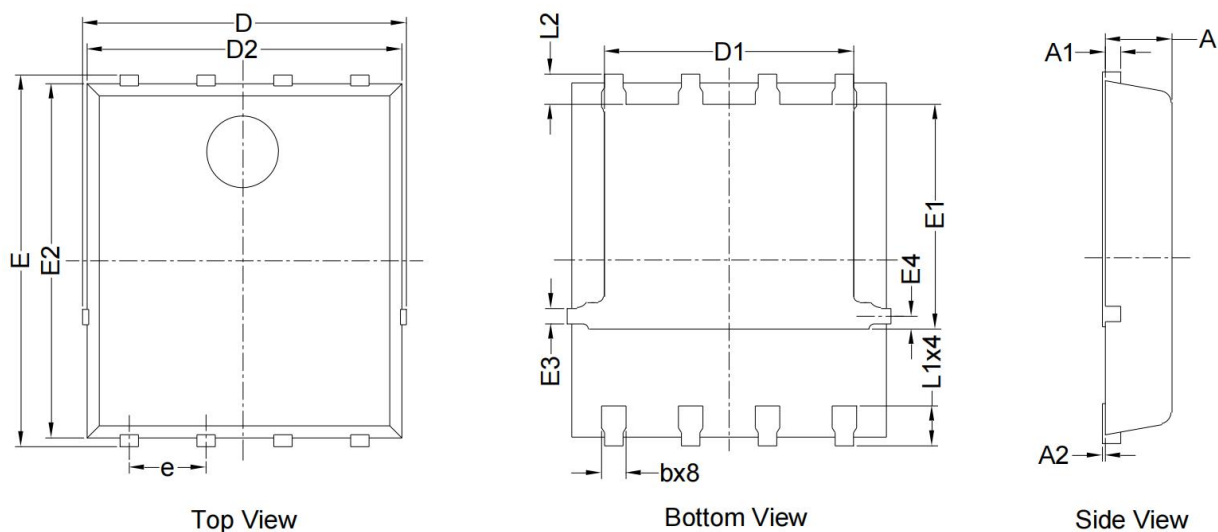

Figure 14. Safe Operation Area

PDFN5*6-8L Package Information



Symbol	Dimensions In Millimeters		Dimensions In Inches	
	Min.	Max.	Min.	Max.
D	5.150	5.550	0.203	0.219
E	5.950	6.350	0.234	0.250
A	1.000	1.200	0.039	0.047
A1	0.254 BSC.		0.010 BSC.	
A2	0.000	0.100	0.000	0.004
D1	3.920	4.320	0.154	0.170
E1	3.520	3.920	0.139	0.154
D2	5.000	5.400	0.197	0.213
E2	5.660	6.060	0.223	0.239
E3	0.254 REF.		0.010 REF.	
E4	0.210 REF.		0.008 REF.	
L1	0.560	0.760	0.022	0.030
L2	0.500 BSC.		0.020 BSC.	
b	0.310	0.510	0.012	0.020
e	1.270 BSC.		0.050 BSC.	