

Product Summary

$V_{(BR)DSS}$	$R_{DS(on)MAX}$	I_D
40V	1.75mΩ@10V	130A
	2.5mΩ@4.5V	

Feature

- Split gate trench MOSFET technology
- High density cell design for low $R_{DS(on)}$
- Excellent package for heat dissipation

Application

- Power switching application
- Uninterruptible power supply
- DC-DC convertor

Package

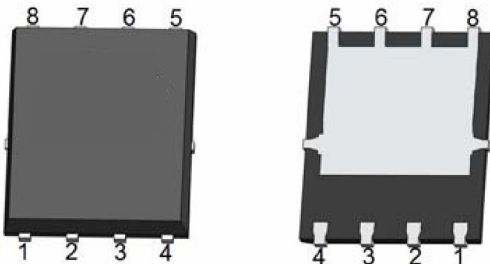

PDFN5*6-8L

Circuit diagram

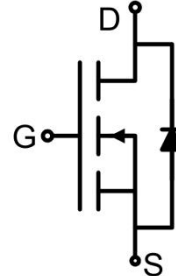

Marking

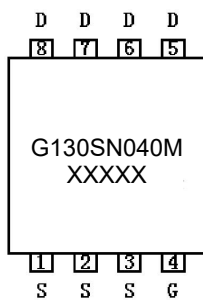

Absolute maximum ratings ($T_A=25^\circ\text{C}$ unless otherwise noted)

Parameter	Symbol	Value	Unit
Drain-Source Voltage	V_{DS}	40	V
Gate-Source Voltage	V_{GS}	± 20	V
Continuous Drain Current ($T_C=25^\circ\text{C}$)	I_D	130	A
Continuous Drain Current ($T_C=100^\circ\text{C}$)	$I_D(100^\circ\text{C})$	82	A
Pulsed Drain Current ¹⁾	I_{DM}	450	A
Single Pulse Avalanche Energy ²⁾	E_{AS}	661	mJ
Power Dissipation ³⁾	P_D	125	W
Thermal Resistance Junction to Case	$R_{\theta JC}$	1	$^\circ\text{C}/\text{W}$
Operating Junction Temperature	T_J	-55 ~ +150	$^\circ\text{C}$
Storage Temperature	T_{STG}	-55 ~ +150	$^\circ\text{C}$

Electrical characteristics ($T_J=25^\circ\text{C}$, unless otherwise noted)

Parameter	Symbol	Test Condition	Min.	Typ.	Max.	Unit
Static Characteristics						
Drain-source breakdown voltage	$V_{(BR)DSS}$	$V_{GS} = 0\text{V}, I_D = 250\mu\text{A}$	40			V
Zero gate voltage drain current	I_{DSS}	$V_{DS} = 40\text{V}, V_{GS} = 0\text{V}$			1	μA
Gate-body leakage current	I_{GSS}	$V_{DS} = 0\text{V}, V_{GS} = \pm 20\text{V}$			± 100	nA
Gate threshold voltage	$V_{GS(th)}$	$V_{DS} = V_{GS}, I_D = 250\mu\text{A}$	1	1.8	2.5	V
Drain-source on-resistance	$R_{DS(on)}$	$V_{GS} = 10\text{V}, I_D = 65\text{A}$		1.45	1.75	m Ω
		$V_{GS} = 4.5\text{V}, I_D = 20\text{A}$		2	2.5	
Dynamic characteristics⁴⁾						
Input Capacitance	C_{iss}	$V_{DS} = 25\text{V}, V_{GS} = 0\text{V}, f = 1\text{MHz}$		7400		pF
Output Capacitance	C_{oss}			1340		
Reverse Transfer Capacitance	C_{rss}			70		
Total Gate Charge	Q_g	$V_{DS} = 20\text{V}, V_{GS} = 10\text{V}, I_D = 20\text{A}$		129		nC
Gate-Source Charge	Q_{gs}			18		
Gate-Drain Charge	Q_{gd}			32		
Turn-on delay time	$t_{d(on)}$	$V_{DS} = 20\text{V}, V_{GS} = 10\text{V}, I_D = 20\text{A}$ $R_G = 2.2\Omega$		28		nS
Turn-on rise time	t_r			113		
Turn-off delay time	$t_{d(off)}$			56		
Turn-off fall time	t_f			21		
Source-Drain Diode characteristics						
Diode Forward Current	I_S				130	A
Diode Forward voltage	V_{SD}	$V_{GS} = 0\text{V}, I_S = 20\text{A}$			1.2	V
Reverse Recovery Time	T_{rr}	$I_F = 20\text{A}, di/dt = -100\text{A}/\mu\text{s}$		73		nS
Reverse Recovery Charge	Q_{rr}			120		nC

Notes:

- 1) Repetitive rating; pulse width limited by max. junction temperature.
- 2) $T_J = 25^\circ\text{C}$, $V_{DS} = 30\text{V}$, $V_G = 10\text{V}$, $R_G = 25\Omega$, $L = 3\text{mH}$, $I_{AS} = 21\text{A}$.
- 3) P_a is based on max. junction temperature, using junction-case thermal resistance.
- 4) Guaranteed by design, not subject to production.

Typical Characteristics

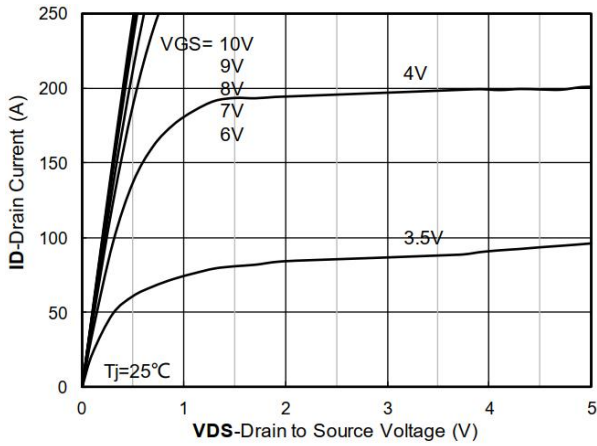

Figure 1. Output Characteristics

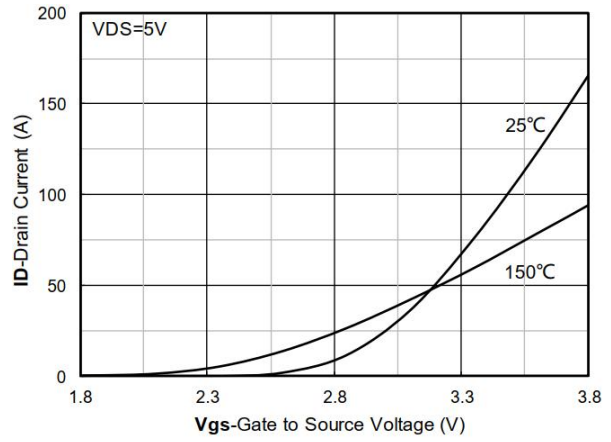

Figure 2. Transfer Characteristics

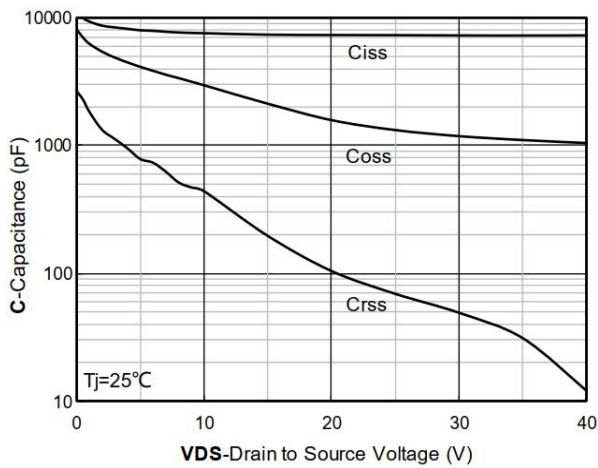

Figure 3. Capacitance Characteristics

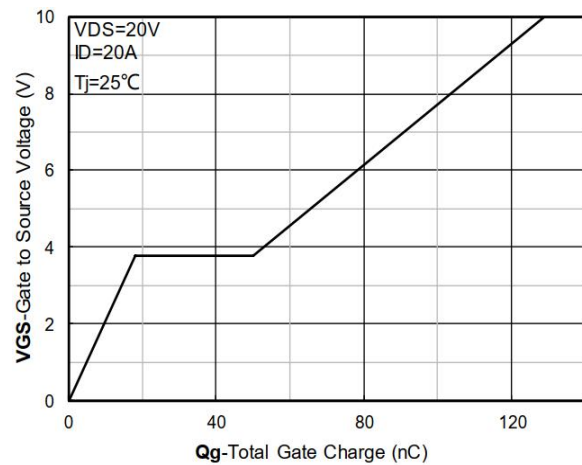

Figure 4. Gate Charge

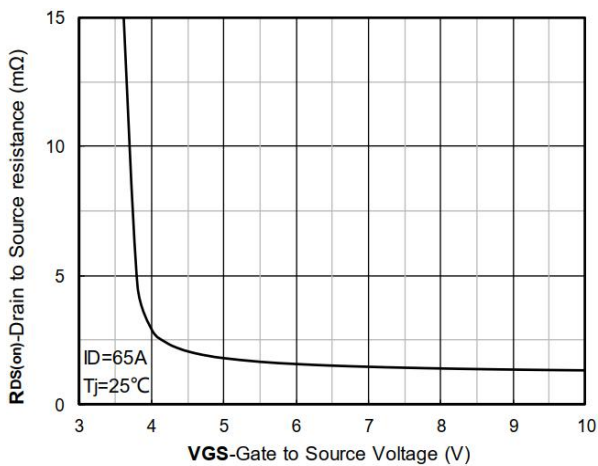

Figure 5. On-Resistance vs Gate to Source Voltage

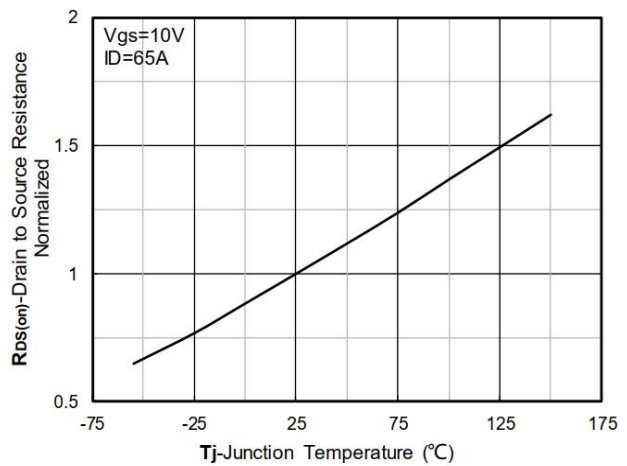

Figure 6. Normalized On-Resistance

Typical Characteristics

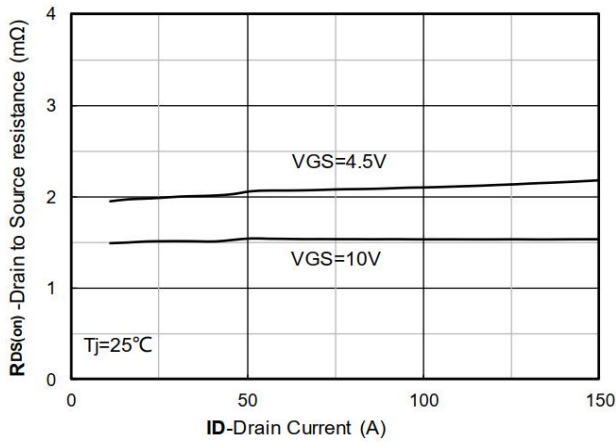

Figure 7. $R_{DS(on)}$ VS Drain Current

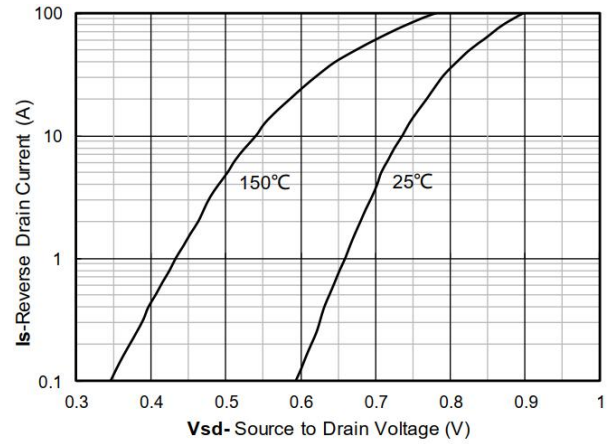

Figure 8. Forward characteristics of reverse diode

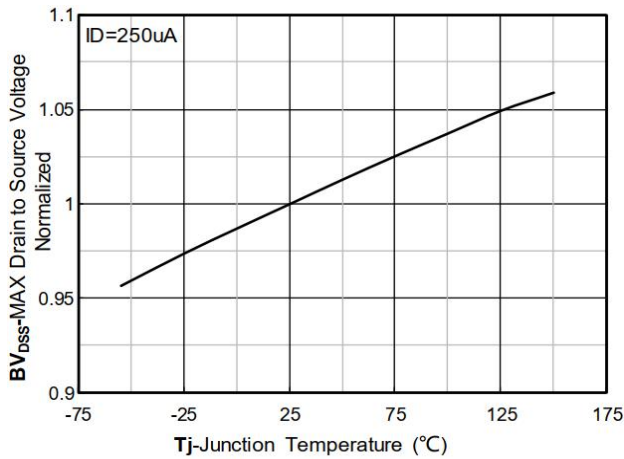

Figure 9. Normalized breakdown voltage

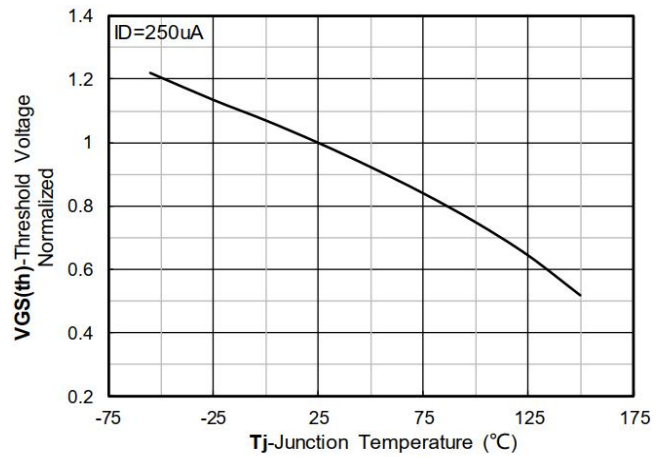

Figure 10. Normalized Threshold voltage

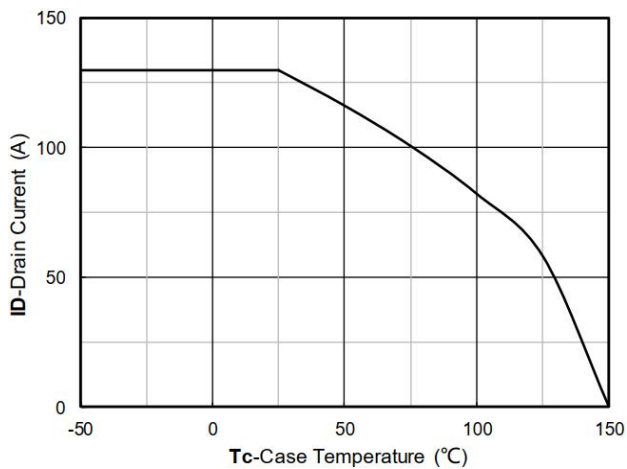

Figure 11. Current dissipation

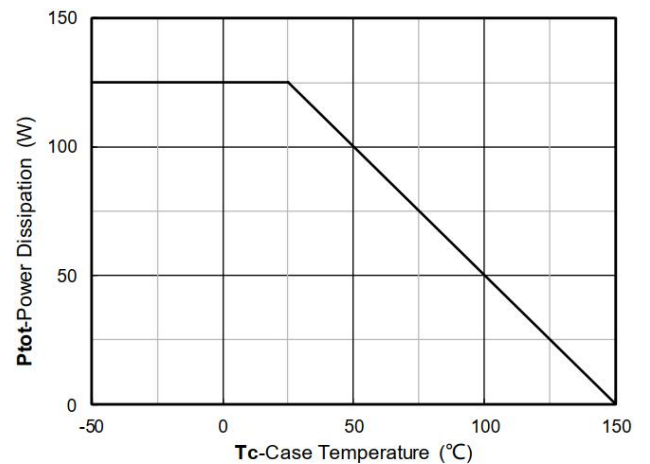

Figure 12. Power dissipation

Typical Characteristics

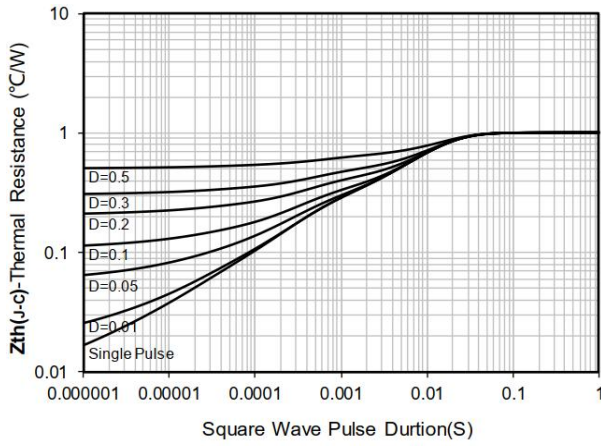

Figure 13. Maximum Transient Thermal Impedance

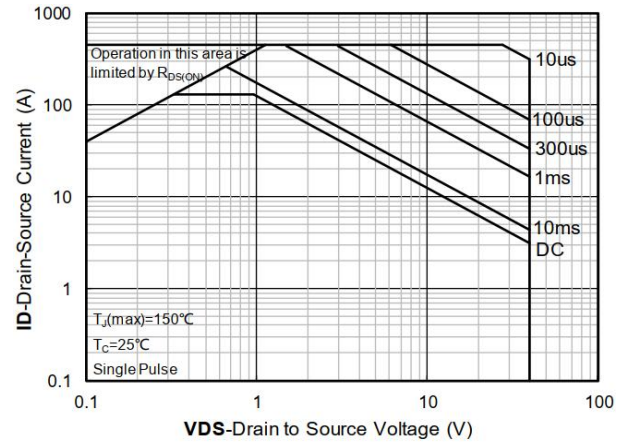
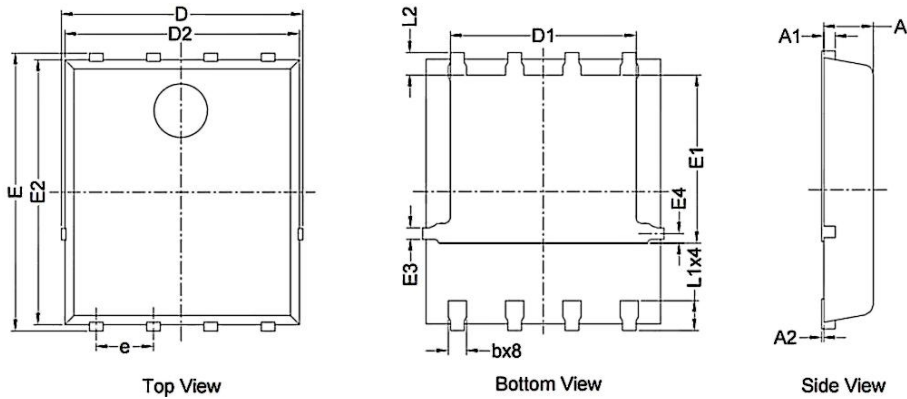
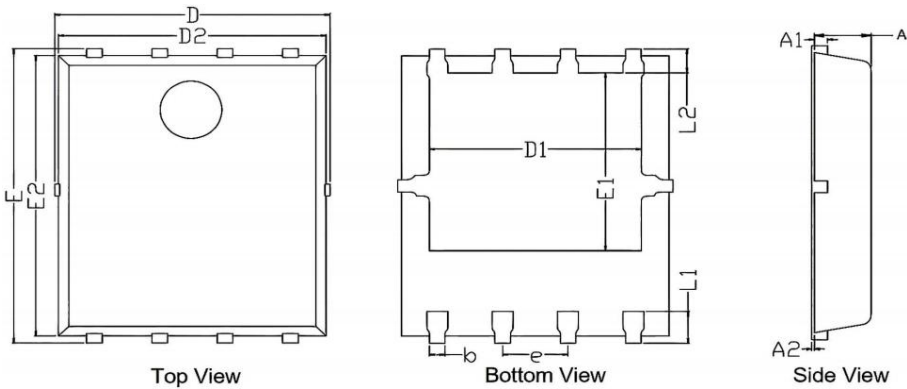

Figure 14. Safe Operation Area

PDFN5*6-8L Package Information



View A



View B

Symbol	Dimensions In Millimeters		Dimensions In Inches	
	Min.	Max.	Min.	Max.
A	0.900	1.200	0.035	0.047
A1	0.254 BSC.		0.010 BSC.	
A2	-	0.100	-	0.004
b	0.200	0.510	0.018	0.020
D	4.850	5.550	0.191	0.219
D1	3.920	4.400	0.154	0.173
D2	4.700	5.400	0.185	0.213
E	5.800	6.350	0.228	0.250
E1	3.350	3.920	0.132	0.154
E2	5.550	6.060	0.219	0.239
E3	0.254 REF.		0.010 REF.	
E4	0.210 REF.		0.008 REF.	
e	1.270 BSC.		0.050 BSC.	
L1	0.550	0.760	0.022	0.030
L2	0.500	0.575	0.020	0.023