

## Product Summary

$V_{(BR)CES}$	$V_{CE(SAT)MAX}$	$I_c$
650V	1.7V@15V	15A

## Feature

- High speed smooth switching device for hard & soft switching
- Positive temperature coefficient
- High ruggedness, temperature stable

## Application

- Soft switching applications
- Air conditioning
- Motor drive inverter

## Package

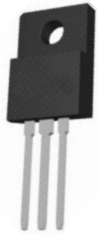

ITO-220AB

## Circuit diagram

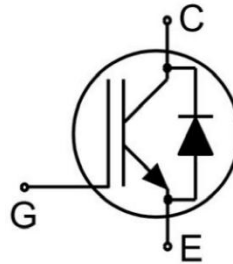

## Marking

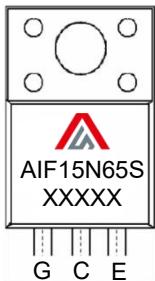

### Absolute maximum ratings (Tc=25°C unless otherwise noted)

Parameter	Symbol	Value	Unit
Collector-Emitter Voltage	$V_{CES}$	650	V
Continuous Gate-Emitter Voltage	$V_{GE}$	$\pm 20$	V
Transient Gate-Emitter Voltage((tp≤10μs,D<0.01)	$V_{GE}$	$\pm 30$	V
DC Collector Current, limited by $T_{jmax}$	$I_C$	20	A
DC Collector Current, limited by $T_{jmax}(T_C = 100^\circ C)$	$I_C(100^\circ C)$	10	A
Diode Forward Current, limited by $T_{jmax}$	$I_F$	20	A
Diode Forward Current, limited by $T_{jmax}(T_C = 100^\circ C)$	$I_F(100^\circ C)$	10	A
Turn off Safe Operating Area $V_{CE} \leq 600V, T_j \leq 150^\circ C$		45	A
Pulsed Collector Current, $V_{GE}=15V, tp$ limited by $T_{jmax}$	$I_{CM}$	45	A
Short Circuit Withstand Time, $V_{GE}= 15V, V_{CE} \leq 400V$	$T_{SC}$	5	μs
Diode Pulsed Current, tp limited by $T_{jmax}$	$I_{Fpuls}$	45	A
Power Dissipation	$P_{tot}$	34	W
Thermal Resistance, Junction to case for Diode	$R_{\theta JC}$	4.8	°C/W
Thermal Resistance, Junction to case for IGBT	$R_{\theta JC}$	4.4	°C/W
Soldering Temperature, wave soldering 1.6mm (0.063in.) from case for 10s		260	°C
Junction Temperature	$T_J$	175	°C
Storage Temperature Range	$T_{STG}$	-55 ~ +150	°C

### Electrical characteristics (Tj=25°C unless otherwise noted)

Parameter	Symbol	Test Condition	Min.	Typ.	Max.	Unit
<b>Static Characteristics</b>						
Collector-Emitter Breakdown Voltage	$V_{(BR)CES}$	$V_{GE} = 0V, I_C = 250\mu A$	650			V
Gate Threshold Voltage	$V_{GE(th)}$	$V_{CE} = V_{GE}, I_C = 1mA$	5.0	5.8	6.5	V
Collector-Emitter Saturation Voltage	$V_{CE(sat)}$	$V_{GE}=15V, I_C=15A$		1.40	1.70	V
		$V_{GE}=15V, I_C=15A, T_j=125^\circ C$		1.55		
		$V_{GE}=15V, I_C=15A, T_j=150^\circ C$		1.60		
Zero Gate Voltage Collector Current	$I_{CES}$	$V_{CE}=650V, V_{GE}=0V$			0.25	mA
		$V_{CE}=650V, V_{GE}=0V, T_j=150^\circ C$			1.00	
Gate to Emitter Leakage Current	$I_{GES}$	$V_{CE} = 0V, V_{GE} = \pm 20V$			$\pm 200$	nA
<b>Dynamic characteristics</b>						
Input Capacitance	$C_{ies}$	$V_{CE}=25V, V_{GE}=0V, f=1MHz$		0.88		nF
Output Capacitance	$C_{oes}$			0.04		
Reverse Transfer Capacitance	$C_{res}$			0.01		
Gate Charge	$Q_g$	$V_{CC}=300V, V_{GE} = 15V, I_C=15A$		0.069		μC
Short circuit collector current	$I_{C(SC)}$	$V_{GE}=15V, t_{sc} \leq 5\mu s, V_{CC}=400V, T_{j,start}=25^\circ C$		110		A

### Switching Characteristic, Inductive Load

Turn-on Delay Time	$t_{d(on)}$	$V_{CC}=300V, V_{GE}=-5V \sim 15V, I_C = 15A, R_G=51\Omega$		10		nS
Rise Time	$t_r$			28		
Turn-off Delay Time	$t_{d(off)}$			68		
Fall time	$t_f$			138		
Turn-off Energy	$E_{off}$			0.16		mJ
Turn-on Energy	$E_{on}$			0.33		

Turn-on Delay Time	$t_{d(on)}$	$V_{CC}=300V, V_{GE}=-5V\sim 15V,$ $I_C = 15A, R_G=51\Omega, T_J=125^\circ C$		14	nS	
Rise Time	$t_r$			36		
Turn-off Delay Time	$t_{d(off)}$			69		
Fall time	$t_f$			161		
Turn-off Energy	$E_{off}$			0.27	mJ	
Turn-on Energy	$E_{on}$			0.38		
Turn-on Delay Time	$t_{d(on)}$	$V_{CC}=300V, V_{GE}=-5V\sim 15V,$ $I_C = 15A, R_G=51\Omega, T_J=150^\circ C$		16	nS	
Rise Time	$t_r$			43		
Turn-off Delay Time	$t_{d(off)}$			69		
Fall time	$t_f$			182		
Turn-off Energy	$E_{off}$				0.32	mJ
Turn-on Energy	$E_{on}$				0.43	

### Electrical characteristics of the Diode ( $T_J=25^\circ C$ unless otherwise noted)

Parameter	Symbol	Test Condition	Min.	Typ.	Max.	Unit
Diode Forward Voltage	$V_F$	$I_F=15A, T_J=25^\circ C$		1.9	2.4	V
		$I_F=15A, T_J=125^\circ C$		1.7		
		$I_F=15A, T_J=150^\circ C$		1.6		
Reverse Recovery Current	$I_{rr}$	$I_F=15A, V_R=300V,$ $-di/dt= 380A/\mu s$		6		A
Diode reverse recovery Time	$t_{rr}$			197		nS
Reverse Recovery Charge	$Q_{rr}$			0.24		$\mu C$
Reverse recovery Energy	$E_{rec}$			0.06		mJ
Reverse Recovery Current	$I_{rr}$	$I_F=15A, V_R=300V,$ $-di/dt= 380A/\mu s, T_J=125^\circ C$		7		A
Diode reverse recovery Time	$t_{rr}$			213		nS
Reverse Recovery Charge	$Q_{rr}$			0.58		$\mu C$
Reverse recovery Energy	$E_{rec}$			0.11		mJ
Reverse Recovery Current	$I_{rr}$	$I_F=15A, V_R=300V,$ $-di/dt= 380A/\mu s, T_J=150^\circ C$		8		A
Diode reverse recovery Time	$t_{rr}$			221		nS
Reverse Recovery Charge	$Q_{rr}$			0.71		$\mu C$
Reverse recovery Energy	$E_{rec}$			0.14		mJ

**Typical Characteristics**

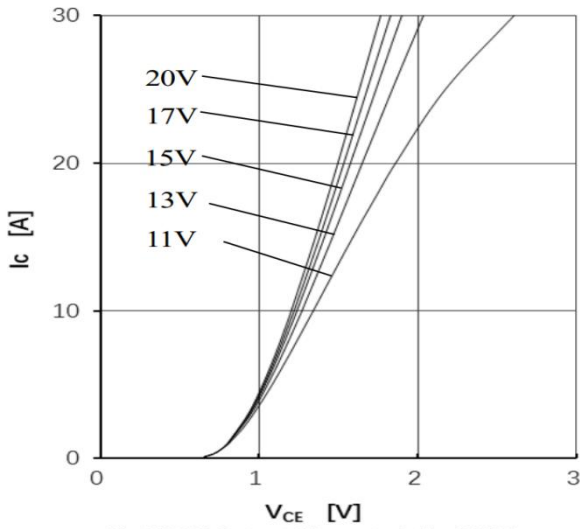

Fig1.IGBT Output Characteristics(25°C)

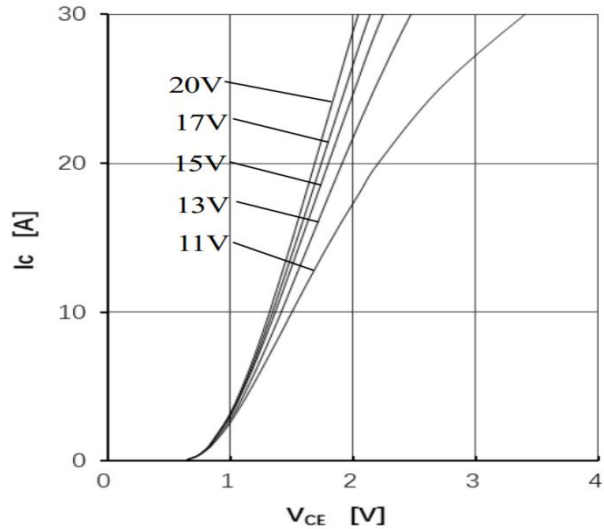

Fig2.IGBT Output Characteristics(150°C)

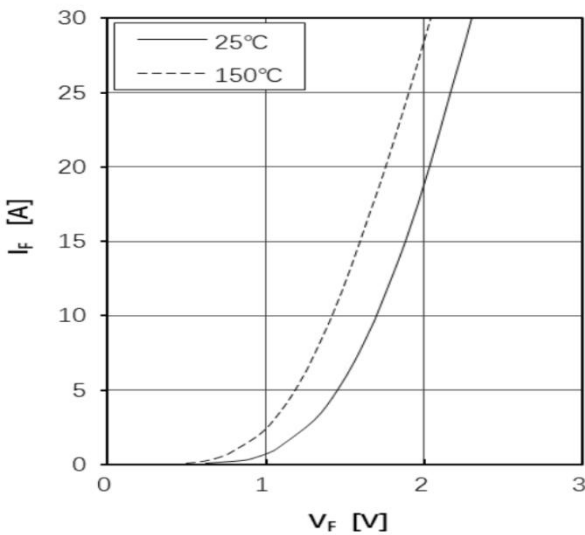

Fig3.Diode Forward Characteristics

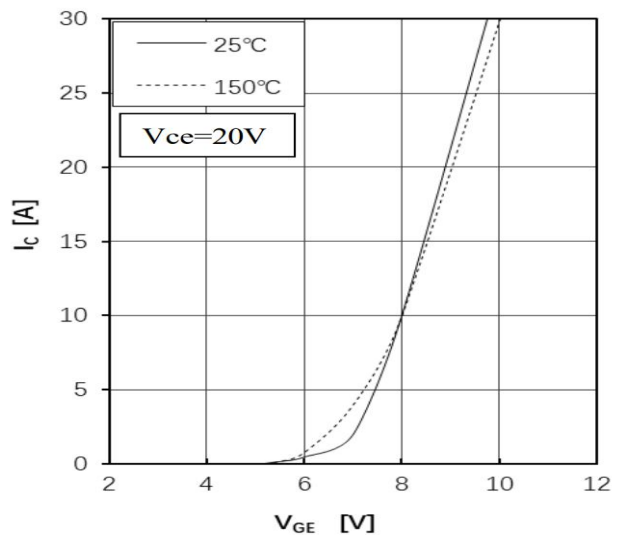

Fig4.IGBT Transfer Characteristics

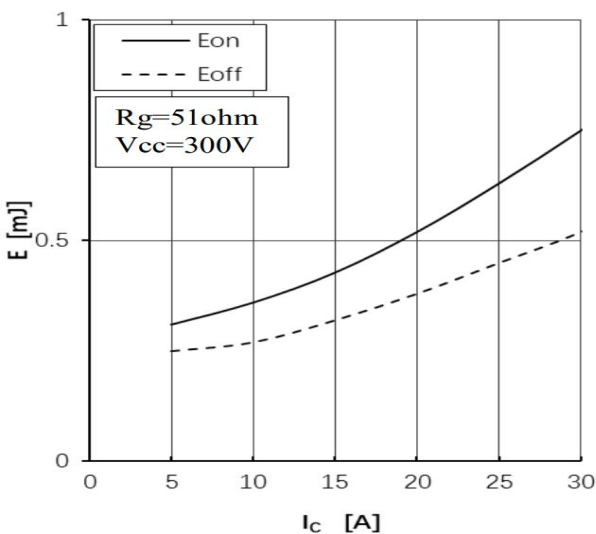

Fig5.IGBT Switching Loss vs. $I_c$ (150°C)

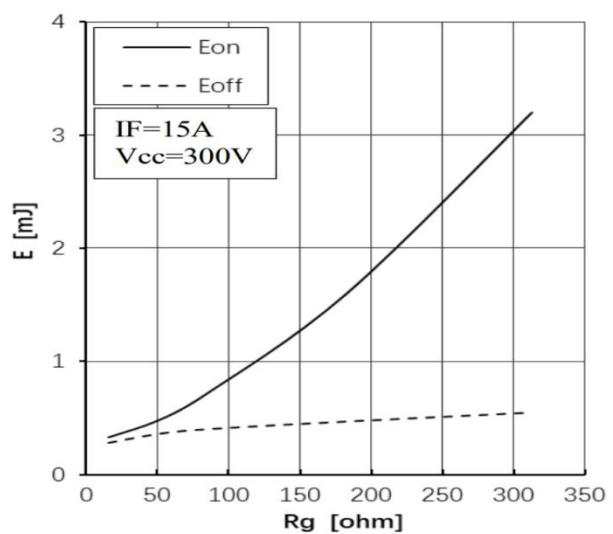

Fig6.IGBT Switching Loss vs. $R_g$ (150°C)

**Typical Characteristics**

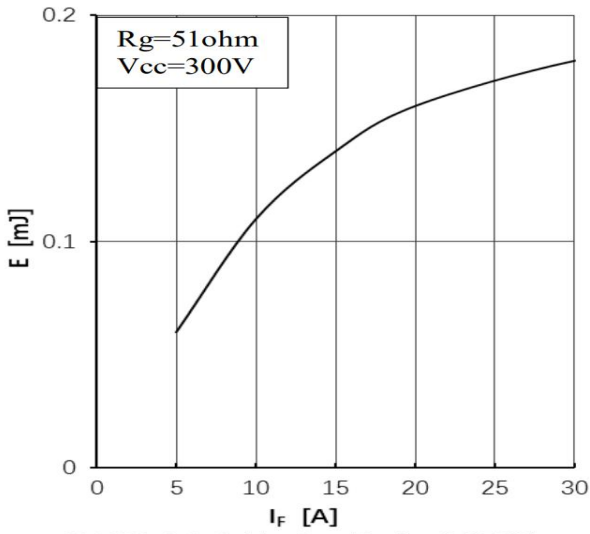

Fig7. Diode Switching Loss(Erec) vs.  $I_F$  (150°C)

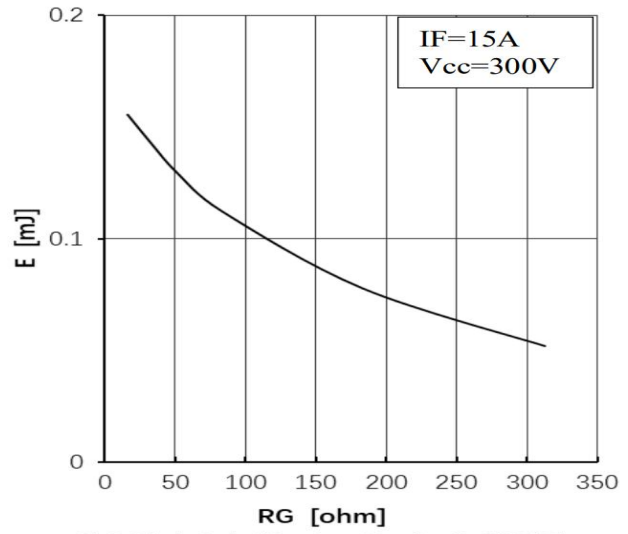

Fig8. Diode Switching Loss(Erec) vs.  $R_G$  (150°C)

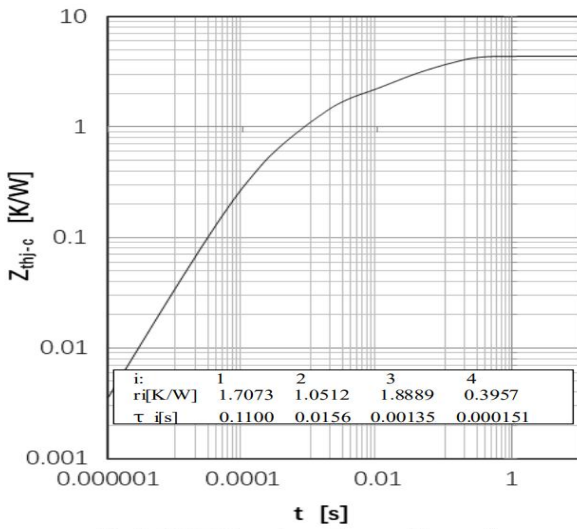

Fig 9. IGBT Transient Thermal Impedance

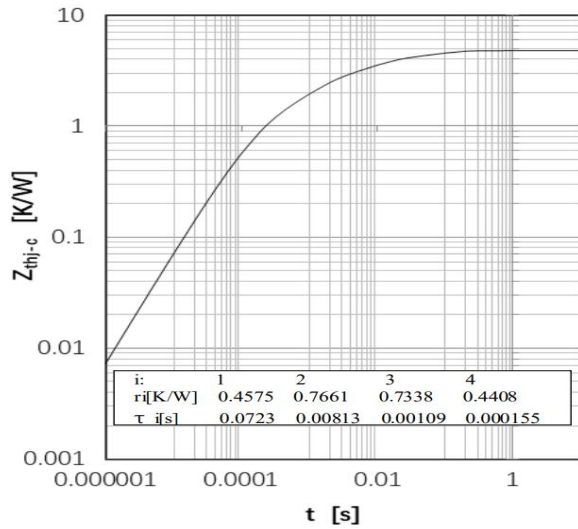
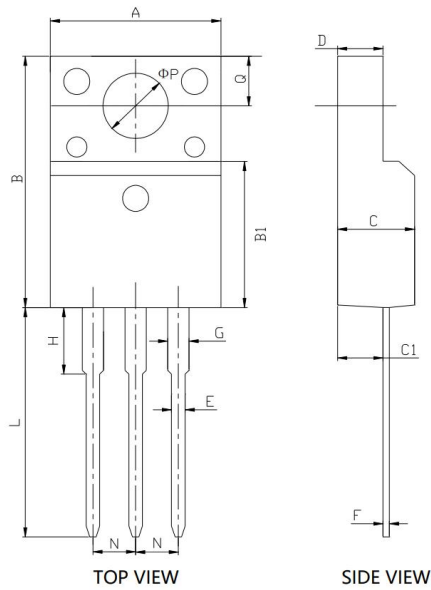

Fig10. Diode Transient Thermal Impedance

## ITO-220AB Package Information



Symbol	Dimensions In Millimeters		Dimensions In Inches	
	Min.	Max.	Min.	Max.
A	9.700	10.300	0.382	0.406
B	15.500	16.100	0.610	0.634
B1	8.990	9.390	0.354	0.370
C	4.400	4.900	0.173	0.193
C1	2.600	2.950	0.102	0.116
D	2.340	2.740	0.092	0.108
E	0.700	0.900	0.028	0.035
F	0.400	0.600	0.016	0.024
G	1.120	1.420	0.044	0.056
H	2.700	3.600	0.106	0.142
L	12.600	13.600	0.496	0.535
N	2.340	2.740	0.092	0.108
Q	3.150	3.550	0.124	0.140
ΦP	3.000	3.300	0.118	0.130