

Product Summary

$V_{(BR)DSS}$	$R_{DS(on)MAX}$	I_D
60V	7.5mΩ@10V	55A
	8.8mΩ@4.5V	

Feature

- Excellent gate charge x $R_{DS(on)}$ product
- Very low on-resistance $R_{DS(on)}$

Application

- DC/DC Converter
- Ideal for high-frequency switching and synchronous rectification

Package



DFN5X6-8L

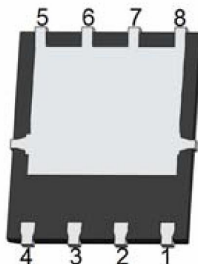

Circuit diagram

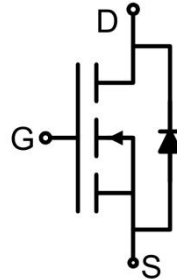

Marking

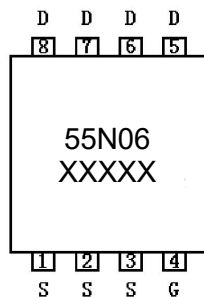

Absolute maximum ratings (T_c=25°C unless otherwise noted)

Parameter	Symbol	Value	Unit
Drain-Source Voltage	V _{DS}	60	V
Gate-Source Voltage	V _{GS}	±20	V
Continuous Drain Current (Silicon limited)	I _D	55	A
Drain Current-Continuous(T _c =100°C)	I _D (100°C)	42.9	A
Pulsed Drain Current	I _{DM}	220	A
Power Dissipation	P _D	65	W
Thermal Resistance,Junction-to-Case	R _{θJC}	1.92	°C/W
Single pulse avalanche energy ³⁾	E _{AS}	350	mJ
Junction Temperature	T _J	150	°C
Storage Temperature	T _{STG}	-55 ~ +150	°C

Electrical characteristics (T_c=25°C unless otherwise noted)

Parameter	Symbol	Test Condition	Min.	Typ.	Max.	Unit
Static Characteristics						
Drain-source breakdown voltage	V _{(BR)DSS}	V _{GS} = 0V, I _D =250μA	60			V
Zero gate voltage drain current	I _{DSS}	V _{DS} =60V, V _{GS} = 0V			1	μA
Gate-body leakage current	I _{GSS}	V _{GS} =±20V, V _{DS} = 0V			±100	nA
Gate threshold voltage	V _{GS(th)}	V _{DS} =V _{GS} , I _D =250μA	1.2	1.8	2.4	V
Drain-source on-resistance ¹⁾	R _{DS(on)}	V _{GS} =10V, I _D =25A		6.5	7.5	mΩ
		V _{GS} =4.5V, I _D =25A		7.7	8.8	
Forward transconductance ¹⁾	g _{FS}	V _{DS} =5V, I _D =25A		60		S
Dynamic characteristics²⁾						
Input Capacitance	C _{iss}	V _{DS} =30V, V _{GS} =0V, f =1MHz		2000		pF
Output Capacitance	C _{oss}			315		
Reverse Transfer Capacitance	C _{rss}			9.9		
Total Gate Charge	Q _g	V _{DS} =30V, V _{GS} =10V, I _D =25A		34.8		nC
Gate-Source Charge	Q _{gs}			7		
Gate-Drain Charge	Q _{gd}			5.3		
Turn-on delay time	t _{d(on)}	V _{DD} =30V, V _{GS} =10V, I _D =25A, R _{GEN} =1.6Ω		8		nS
Turn-on rise time	t _r			2		
Turn-off delay time	t _{d(off)}			29		
Turn-off fall time	t _f			4		
Source-Drain Diode characteristics						
Diode Forward Current	I _S				55	A
Diode Forward voltage ¹⁾	V _{DS}	V _{GS} =0V, I _S =25A			1.2	V
Reverse Recovery Time	t _{rr}	T _J = 25°C, I _F =25A		38		nS
Reverse Recovery Charge	Q _{rr}	di/dt = 100A/μs ¹⁾		48		nC

Notes:

- 1) Pulse Test: Pulse Width < 300μs, Duty Cycle ≤2%.
- 2) Guaranteed by design, not subject to production testing.
- 3) EAS condition : T_J=25°C, V_{DD}=30V, V_G=10V, L=0.5mH, R_g=25Ω

Typical Characteristics

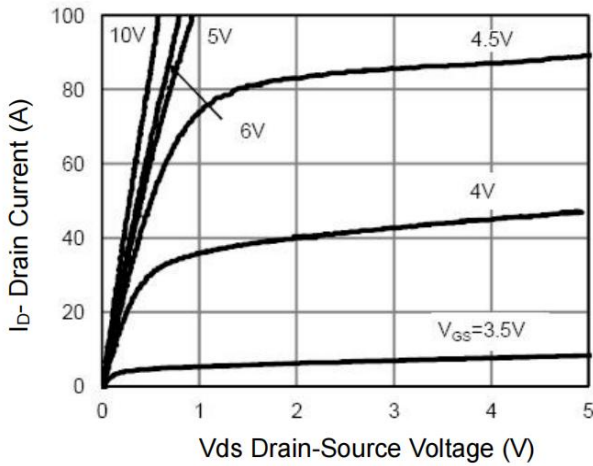

Figure 1 Output Characteristics

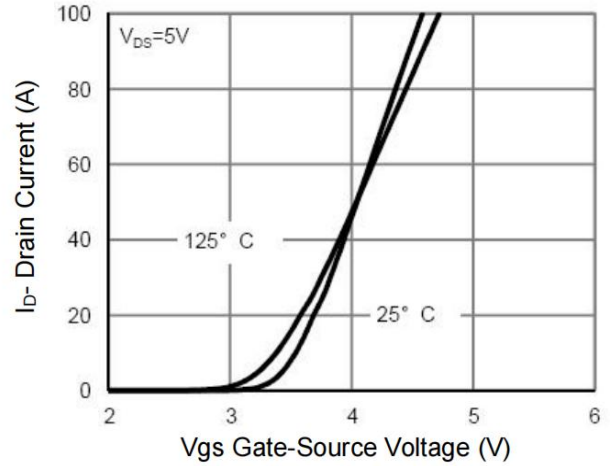

Figure 2 Transfer Characteristics

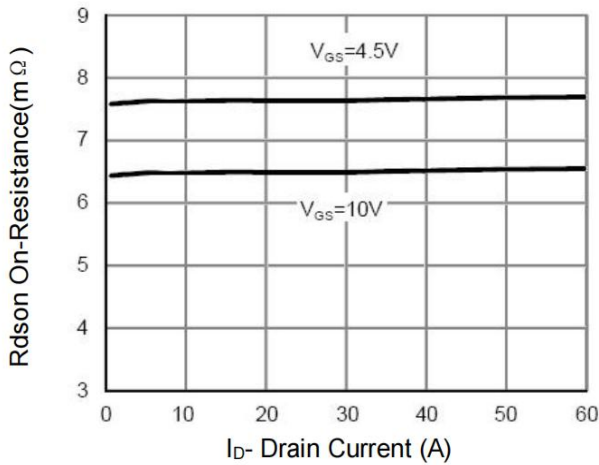

Figure 3 Rdson- Drain Current

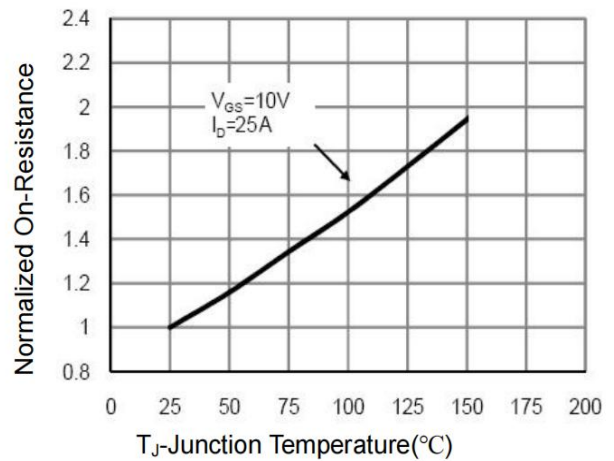

Figure 4 Rdson-Junction Temperature

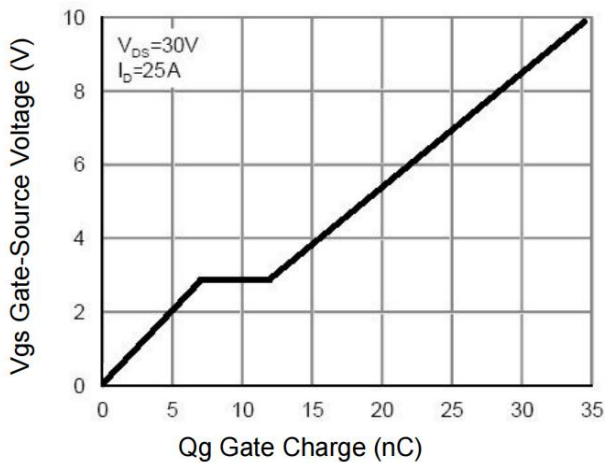

Figure 5 Gate Charge

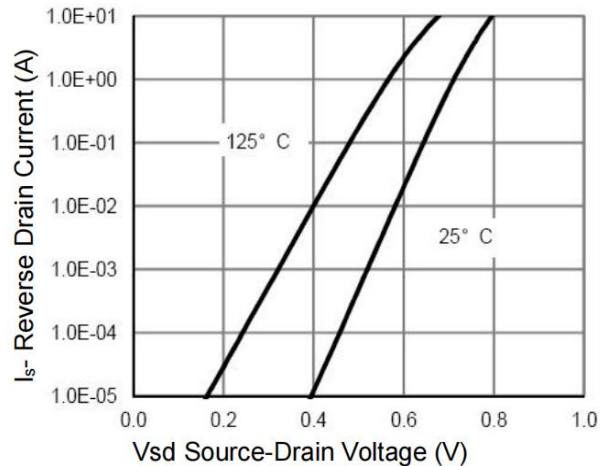

Figure 6 Source- Drain Diode Forward

Typical Characteristics

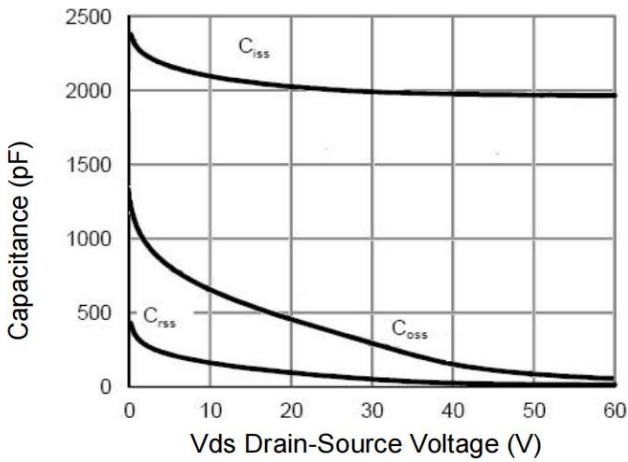

Figure 7 Capacitance vs Vds

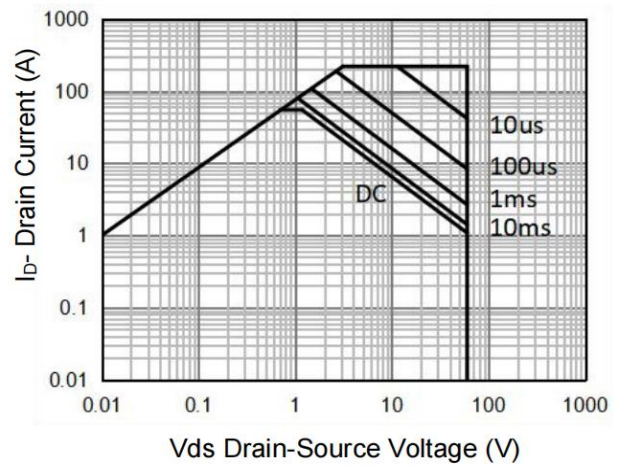

Figure 8 Safe Operation Area

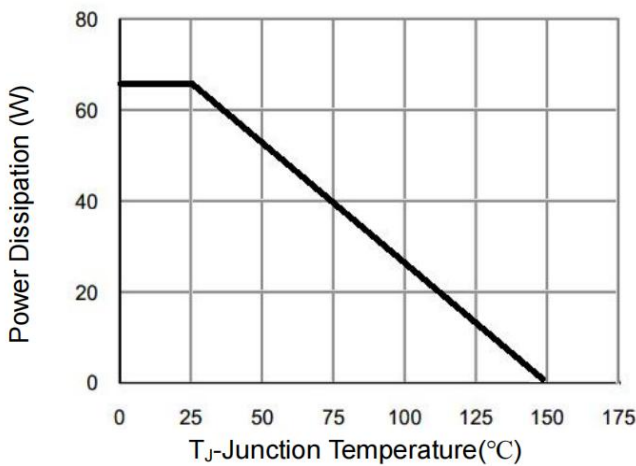

Figure 9 Power De-rating

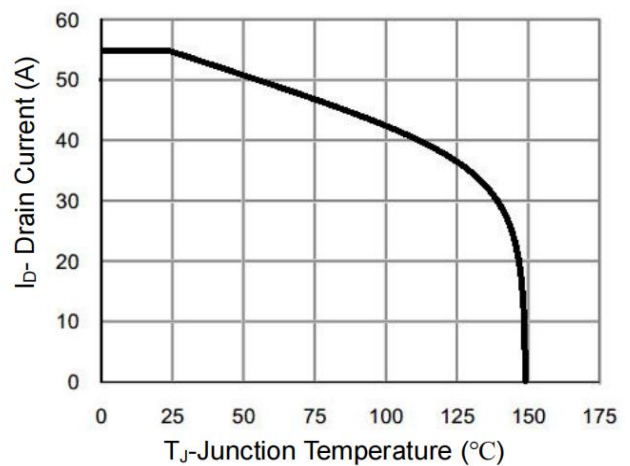

Figure 10 Current De-rating

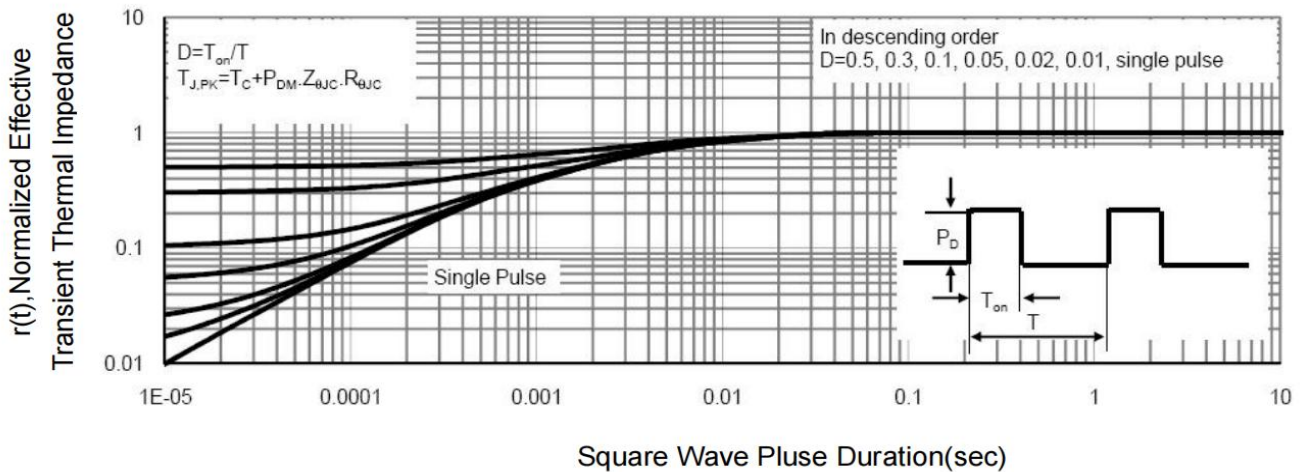
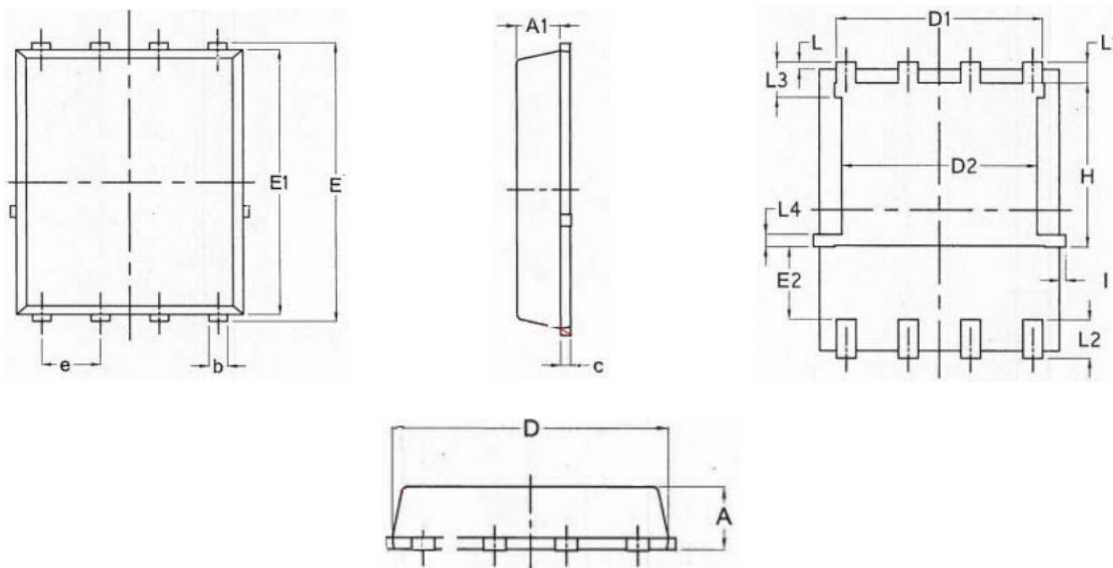

Figure 11 Normalized Maximum Transient Thermal Impedance

DFN5X6-8L Package Information



Symbol	Dimensions In Millimeters		Dimensions In Inches	
	Min.	Max.	Min.	Max.
A	0.900	1.170	0.035	0.046
A1	0.824	0.970	0.032	0.038
b	0.330	0.500	0.013	0.020
C	0.150	0.300	0.006	0.0122
D	4.800	5.000	0.189	0.197
D1	3.910	4.360	0.154	0.172
D2	3.610	4.150	0.142	0.163
e	1.270BSC		0.050BSC	
E	5.900	6.150	0.232	0.242
E1	5.650	5.850	0.222	0.230
E2	1.100	-	0.043	-
L	0.050	0.250	0.002	0.010
L1	0.380	0.610	0.015	0.024
L2	0.510	0.860	0.020	0.034
L3	0.550	0.850	0.022	0.034
L4	0.100	0.400	0.004	0.016
H	3.250	3.780	0.128	0.149
I	0.000	0.180	0.000	0.007