

Product Summary

$V_{(BR)DSS}$	$R_{DS(on)MAX}$	I_D
60V	2.0mΩ@10V	210A

Feature

- Excellent gate charge x $R_{DS(on)}$ product (FOM)
- Very low on-resistance $R_{DS(on)}$

Application

- DC/DC Converter
- Ideal for high-frequency switching and synchronous rectification

Package

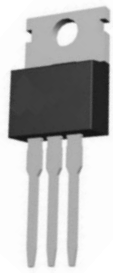

TO-220AB

Circuit diagram

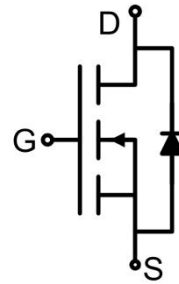

Marking

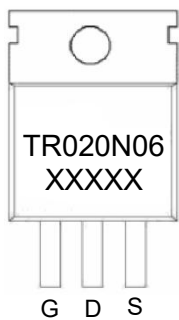

Absolute maximum ratings (T_c=25°C unless otherwise noted)

Parameter	Symbol	Value	Unit
Drain-Source Voltage	V _{DS}	60	V
Gate-Source Voltage	V _{GS}	±20	V
Continuous Drain Current	I _D	210	A
Continuous Drain Current(T _c =100°C)	I _D (100°C)	157	A
Pulsed Drain Current	I _{DM}	840	A
Power Dissipation	P _D	255	W
Thermal Resistance,Junction-to-Case	R _{θJC}	0.59	°C/W
Single pulse avalanche energy ¹⁾	E _{AS}	2332	mJ
Junction Temperature	T _J	175	°C
Storage Temperature	T _{STG}	-55 ~ +175	°C

Electrical characteristics (T_c=25 °C unless otherwise noted)

Parameter	Symbol	Test Condition	Min.	Typ.	Max.	Unit
Static Characteristics						
Drain-source breakdown voltage	V _{(BR)DSS}	V _{GS} = 0V, I _D = 250μA	60			V
Zero gate voltage drain current	I _{DSS}	V _{DS} = 60V, V _{GS} = 0V			1	μA
Gate-body leakage current	I _{GSS}	V _{GS} = ±20V, V _{DS} = 0V			±100	nA
Gate threshold voltage	V _{GS(th)}	V _{DS} = V _{GS} , I _D = 250μA	2.0	3.0	4.0	V
Drain-source on-resistance	R _{DS(on)}	V _{GS} = 10V, I _D = 20A		1.7	2.0	mΩ
Forward Transconductance	g _{FS}	V _{DS} = 5V, I _D = 20A		150		S
Dynamic characteristics²⁾						
Input Capacitance	C _{iss}	V _{DS} = 30V, V _{GS} = 0V, f = 1.0MHz		9433		pF
Output Capacitance	C _{oss}			1647		
Reverse Transfer	C _{rss}			92.6		
Total Gate Charge	Q _g	V _{DS} = 30V, V _{GS} = 10V, I _D = 20A		141		nC
Gate-Source Charge	Q _{gs}			40		
Gate-Drain Charge	Q _{gd}			26.7		
Turn-on delay time	t _{d(on)}	V _{DD} = 30V, V _{GS} = 10V, I _D = 20A, R _G = 1.8Ω		20		nS
Turn-on rise time	t _r			29		
Turn-off delay time	t _{d(off)}			50		
Turn-off fall time	t _f			25		
Source-Drain Diode characteristics						
Diode Forward Current	I _S				210	A
Diode Forward voltage	V _{SD}	V _{GS} = 0V, I _S = 210A			1.2	V
Reverse Recovery Time	t _{rr}	T _J = 25°C, I _F = I _S di/dt = 100A/μs		80		nS
Reverse Recovery Charge	Q _{rr}			175		nC

Notes:

1) EAS condition : T_J = 25°C, V_{DD} = 30V, V_G = 10V, L = 0.5mH, R_G = 25Ω

2) Guaranteed by design, not subject to production

Typical Characteristics

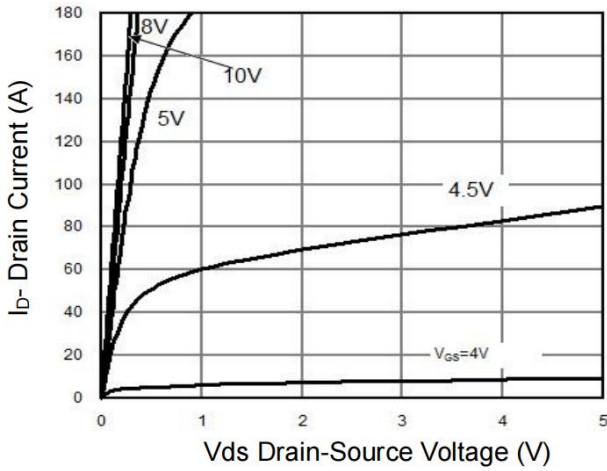

Figure 1 Output Characteristics

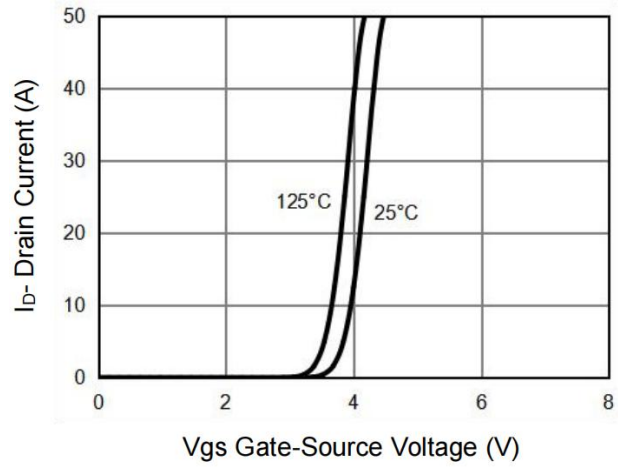

Figure 2 Transfer Characteristics

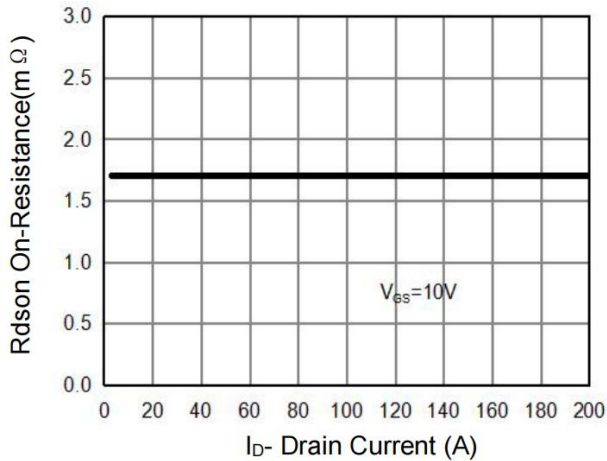

Figure 3 Rdson- Drain Current

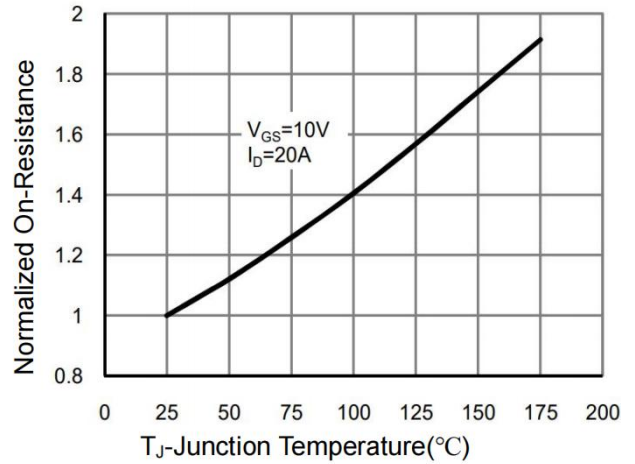

Figure 4 Rdson-Junction Temperature

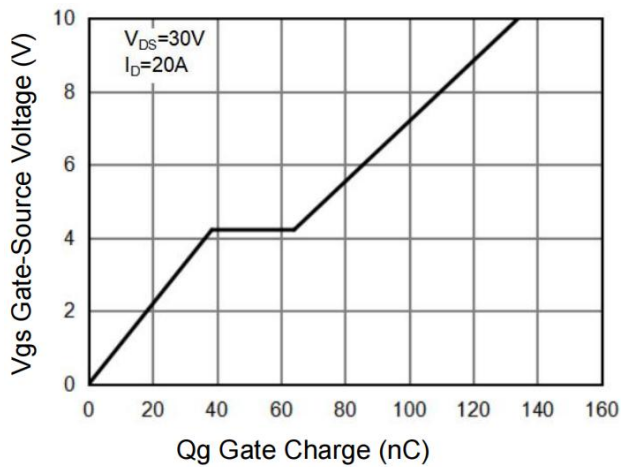

Figure 5 Gate Charge

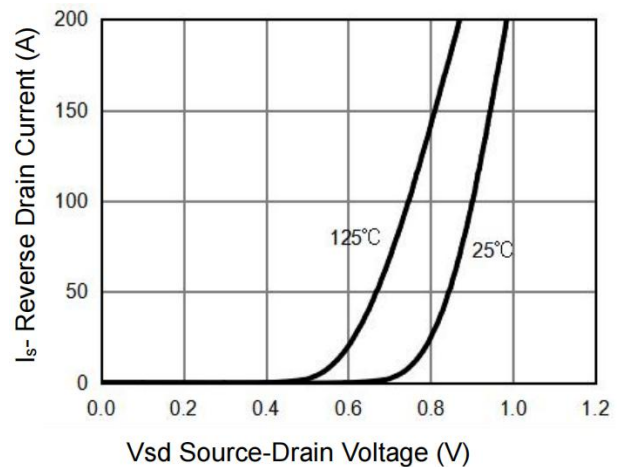

Figure 6 Source- Drain Diode Forward

Typical Characteristics

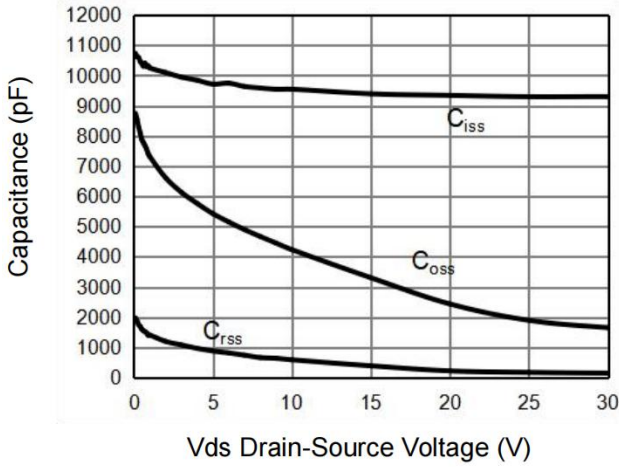

Figure 7 Capacitance vs Vds

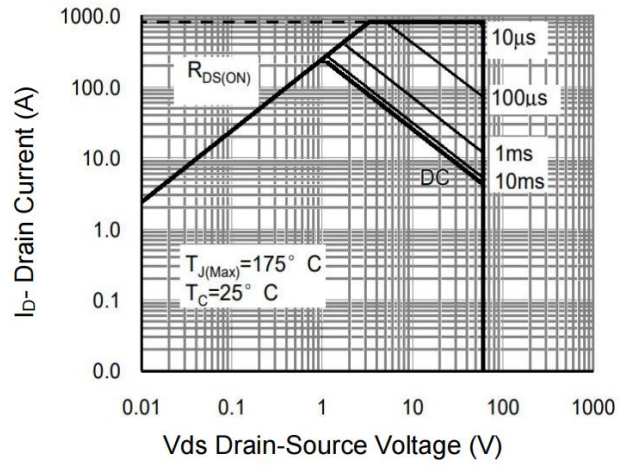

Figure 8 Safe Operation Area

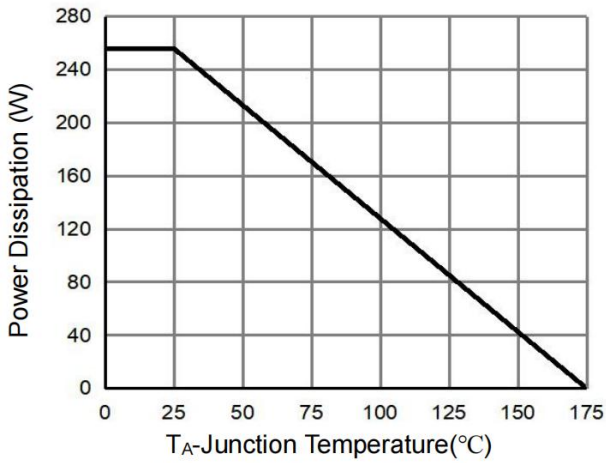

Figure 9 Power De-rating

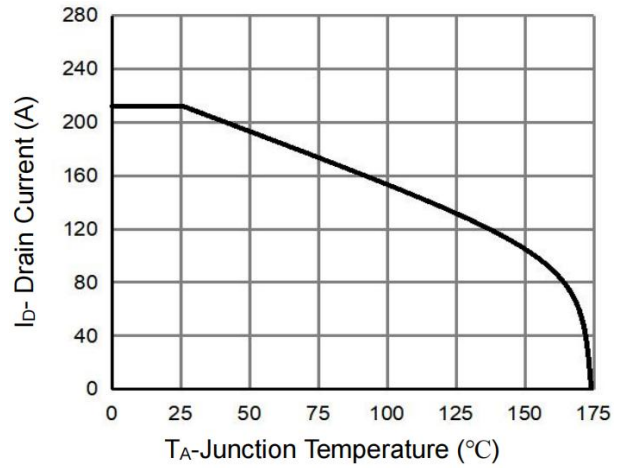

Figure 10 Current De-rating

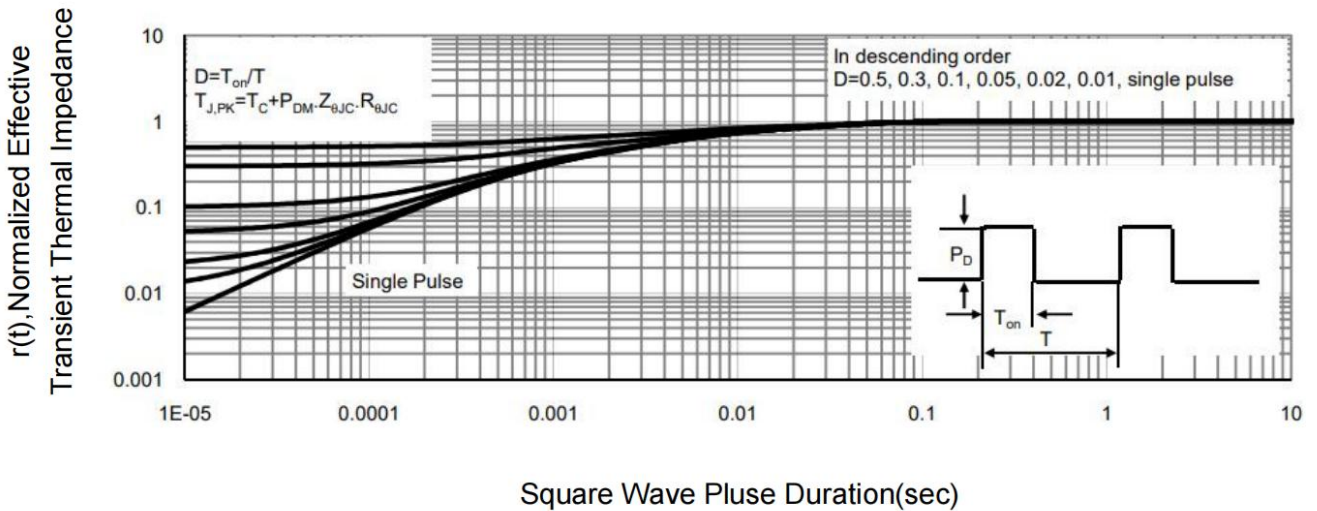
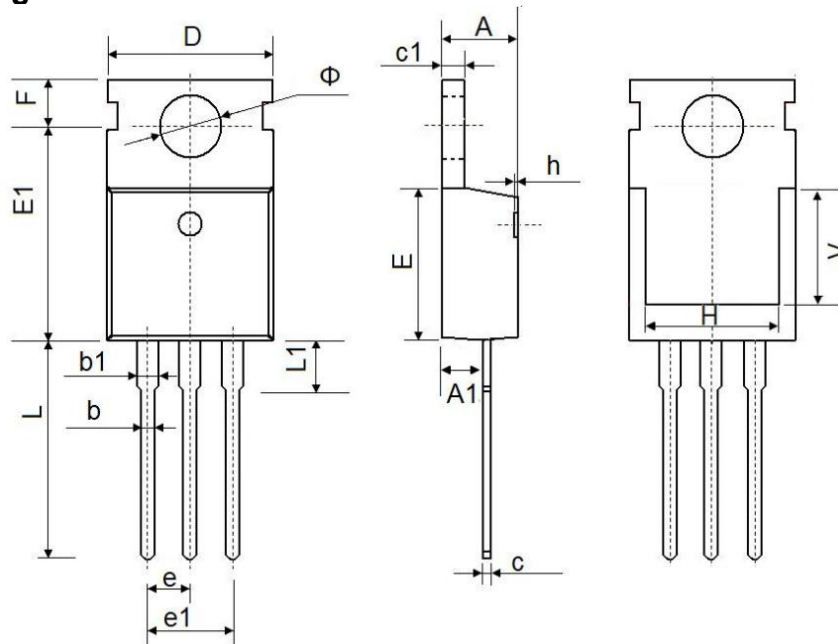

Figure 11 Normalized Maximum Transient Thermal Impedance

TO-220AB Package Information



Symbol	Dimensions In Millimeters		Dimensions In Inches	
	Min.	Max.	Min.	Max.
A	4.400	4.600	0.173	0.181
A1	2.250	2.550	0.089	0.100
b	0.710	0.910	0.028	0.036
b1	1.170	1.370	0.046	0.054
c	0.330	0.650	0.013	0.026
c1	1.200	1.400	0.047	0.055
D	9.910	10.250	0.390	0.404
E	8.950	9.750	0.352	0.384
E1	12.650	12.950	0.498	0.510
e	2.540 TYP.		0.100 TYP.	
e1	4.980	5.180	0.196	0.204
F	2.650	2.950	0.104	0.116
H	7.900	8.100	0.311	0.319
h	0.000	0.300	0.000	0.012
L	12.900	13.400	0.508	0.528
L1	2.850	3.250	0.112	0.128
V	6.900 REF.		0.276REF.	
Φ	3.400	3.800	0.134	0.150