

FEATURES

- Low turn-on voltage
- Fast switching
- Also available in lead free version
- Compliant to Halogen-free
- Suffix "-Q1" for AEC-Q101

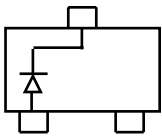

BAS70-Q1 Marking: 73

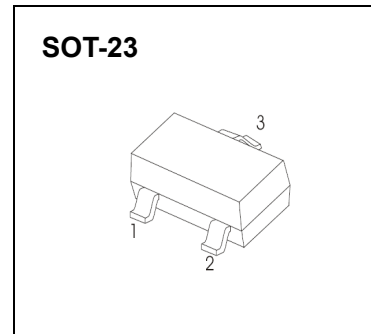
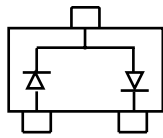

BAS70-04-Q1 Marking: 74

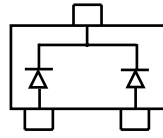

BAS70-05-Q1 Marking: 75

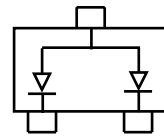

BAS70-06-Q1 Marking: 76

MAXIMUM RATINGS @Ta=25°C

Symbol	Parameter	Value	Unit
V_R	DC Voltage	70	V
I_F	Forward Continuous Current	70	mA
P_D	Power Dissipation	200	mW
$R_{\theta JA}$	Thermal Resistance from Junction to Ambient	500	°C/W
T_J	Junction Temperature	125	°C
T_{stg}	Storage Temperature	-55~+150	°C

ELECTRICAL CHARACTERISTICS (Ta=25°C unless otherwise specified)

Parameter	Symbol	Test conditions	Min	Max	Unit
Reverse breakdown voltage	$V_{(BR)}$	$I_R = 10\mu A$	70		V
Reverse voltage leakage current	I_R	$V_R = 50V$		120	nA
Forward voltage	V_F	$I_F = 1mA$ $I_F = 15mA$		720 1000	mV
Diode capacitance	C_D	$V_R = 0V$ $f = 1MHz$		2	pF
Reverse recovery time	t_{rr}	$I_F = I_R = 10mA, I_{rr} = 0.1 \times I_R,$ $R_L = 100\Omega$		5	ns

Forward characteristics

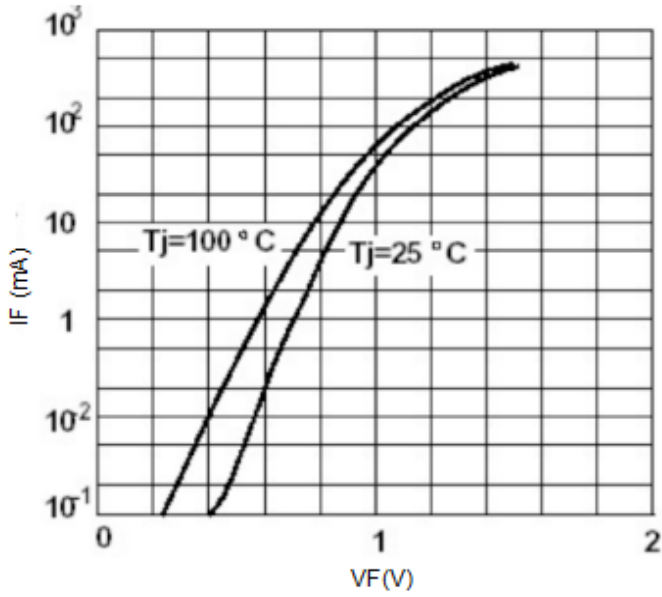

Reverse characteristics

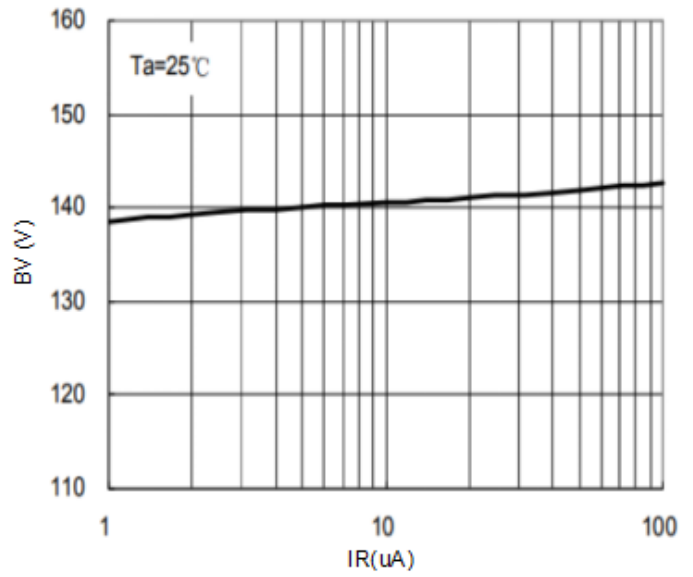

Capacitance Characteristics

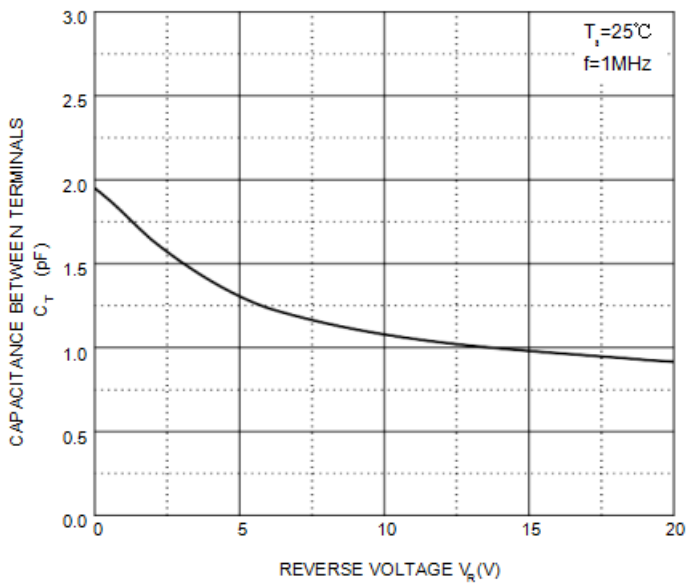

Power Derating Curve

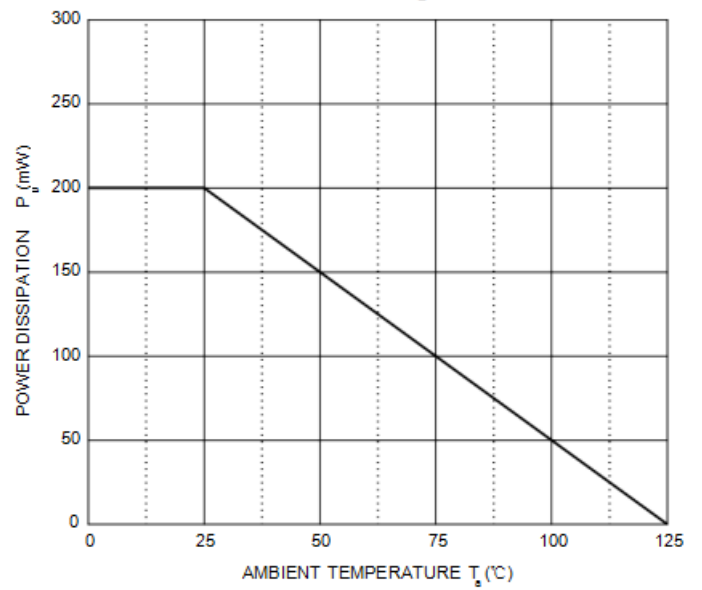

SOT-23 Package Outline Dimensions

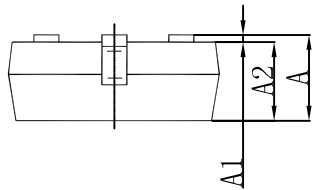
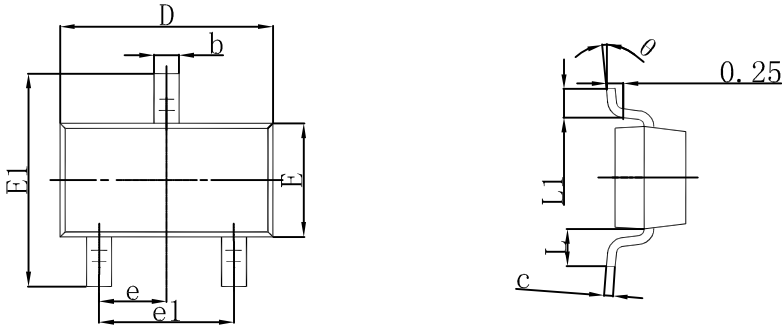

Symbol	Dimensions In Millimeters		Dimensions In Inches	
	Min	Max	Min	Max
A	0.900	1.150	0.035	0.045
A1	0.000	0.100	0.000	0.004
A2	0.900	1.050	0.035	0.041
b	0.300	0.500	0.012	0.020
c	0.080	0.150	0.003	0.006
D	2.800	3.000	0.110	0.118
E	1.200	1.400	0.047	0.055
E1	2.250	2.550	0.089	0.100
e	0.950 TYP		0.037 TYP	
e1	1.800	2.000	0.071	0.079
L	0.550 REF		0.022 REF	
L1	0.300	0.500	0.012	0.020
θ	0°	8°	0°	6°

SOT-23 Suggested Pad Layout

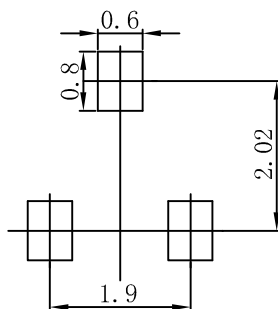

- Note:
1. Controlling dimension: in millimeters.
 2. General tolerance: $\pm 0.05\text{mm}$.
 3. The pad layout is for reference purposes only.