

FEATURES

- Low turn-on voltage
- Fast switching
- Also available in lead free version
- Compliant to Halogen-free

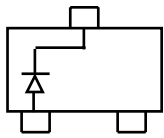

BAS70 Marking: 73

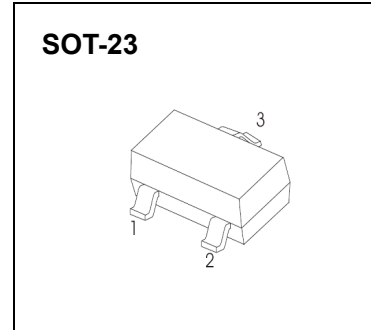
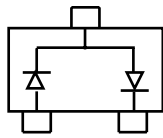

BAS70-04 Marking: 74

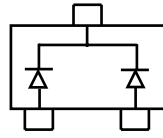

BAS70-05 Marking: 75

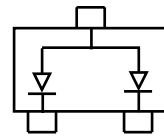

BAS70-06 Marking: 76

MAXIMUM RATINGS @Ta=25°C

Symbol	Parameter	Value	Unit
V_R	DC Voltage	70	V
I_F	Forward Continuous Current	70	mA
P_D	Power Dissipation	200	mW
$R_{\theta JA}$	Thermal Resistance from Junction to Ambient	500	°C/W
T_J	Junction Temperature	125	°C
T_{stg}	Storage Temperature	-55~+150	°C

ELECTRICAL CHARACTERISTICS (Ta=25°C unless otherwise specified)

Parameter	Symbol	Test conditions	Min	Max	Unit
Reverse breakdown voltage	$V_{(BR)}$	$I_R=10\mu A$	70		V
Reverse voltage leakage current	I_R	$V_R=50V$		120	nA
Forward voltage	V_F	$I_F=1mA$ $I_F=15mA$		720 1000	mV
Diode capacitance	C_D	$V_R=0V$ $f=1MHz$		2	pF
Reverse recovery time	t_{rr}	$I_F=I_R=10mA, I_{rr}=0.1 \times I_R,$ $R_L=100\Omega$		5	ns

Forward characteristics

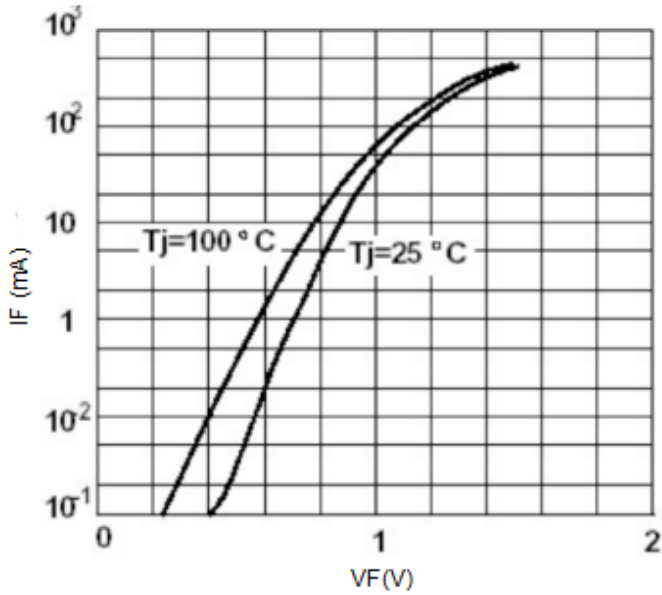

Reverse characteristics

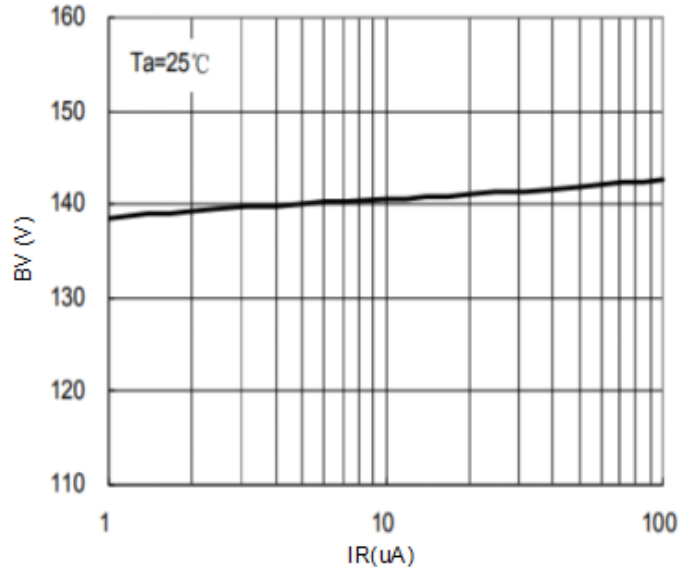

Capacitance Characteristics

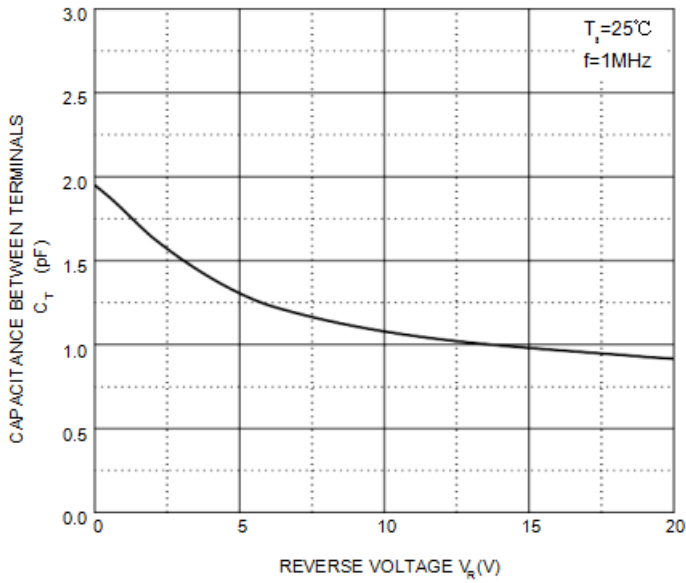

Power Derating Curve

