

### FEATURES

- Low Forward Voltage Drop
- Fast Switching
- PN Junction Guard Ring for Transient and ESD Protection
- Compliant to Halogen-free
- Suffix "-Q1" for AEC-Q101

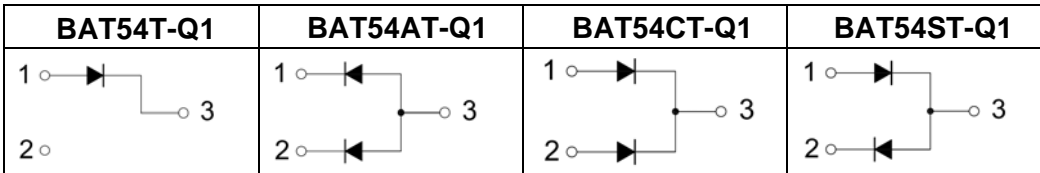

### MARKING:

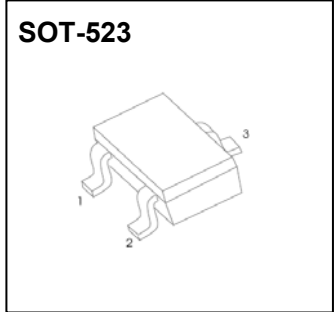
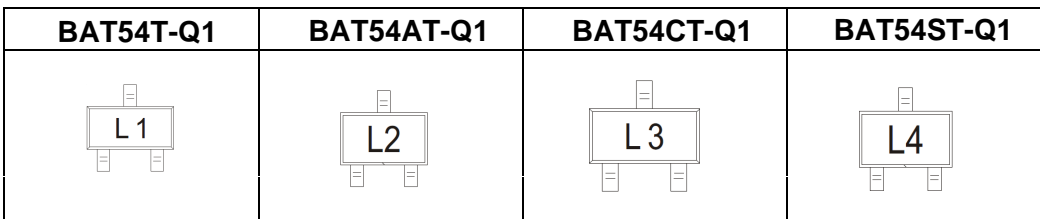

### MAXIMUM RATINGS ( T<sub>a</sub>=25°C unless otherwise noted )

Symbol	Parameter	Value	Unit
V <sub>RRM</sub>	Peak Repetitive Reverse Voltage	30	V
V <sub>RWM</sub>	Working Peak Reverse Voltage		
V <sub>R(RMS)</sub>	RMS Reverse Voltage	21	V
I <sub>O</sub>	Average Rectified Output Current	0.2	A
I <sub>FSM</sub>	Non-repetitive Peak Forward Surge Current @ t=8.3ms	600	mA
I <sub>FRM</sub>	Repetitive Peak Forward Surge Current @ t≤1s; δ ≤0.5	300	mA
P <sub>D</sub>	Power Dissipation	150	mW
R <sub>θJA</sub>	Thermal Resistance from Junction to Ambient	667	°C/W
T <sub>j</sub>	Junction Temperature	125	°C
T <sub>stg</sub>	Storage Temperature	-55~+150	°C

### ELECTRICAL CHARACTERISTICS(T<sub>a</sub>=25°C unless otherwise specified)

Parameter	Symbol	Test conditions	Min	Typ	Max	Unit
Reverse voltage	V <sub>(BR)</sub>	I <sub>R</sub> =100μA	30			V
Reverse current	I <sub>R</sub>	V <sub>R</sub> =25V			2	μA
Forward voltage	V <sub>F</sub>	I <sub>F</sub> =1mA			0.32	V
		I <sub>F</sub> =10mA			0.4	
		I <sub>F</sub> =30mA			0.5	
		I <sub>F</sub> =100mA			1	
Total capacitance	C <sub>tot</sub>	V <sub>R</sub> =1V, f=1MHz			10	pF
Reverse recovery time	t <sub>rr</sub>	I <sub>F</sub> = I <sub>R</sub> =10mA, I <sub>rr</sub> =0.1×I <sub>R</sub> , R <sub>L</sub> =100Ω			5	ns

## Typical Characteristics

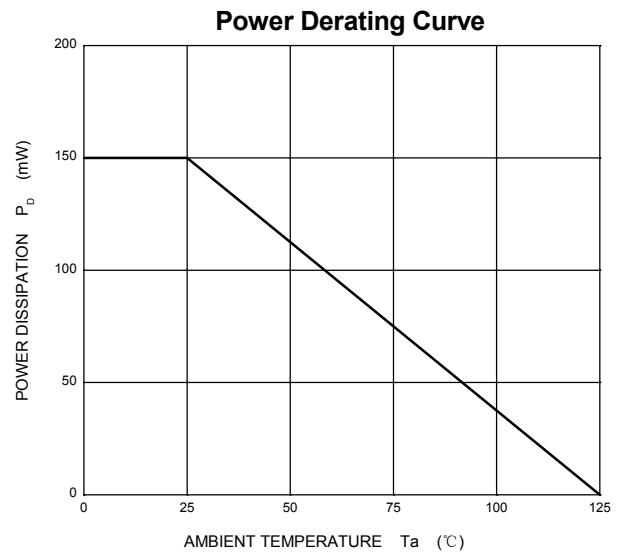
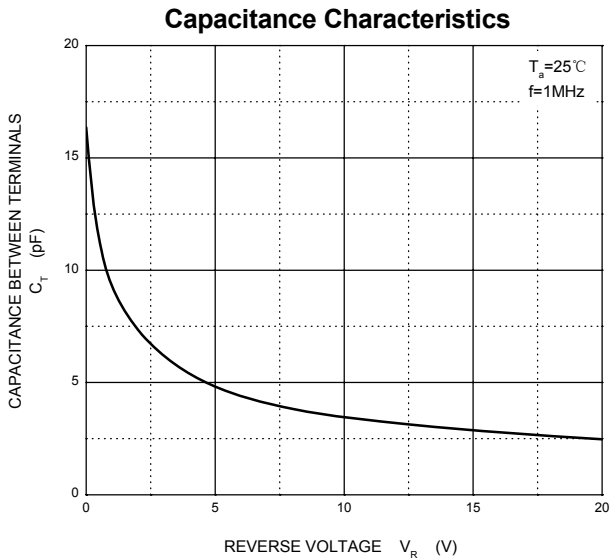
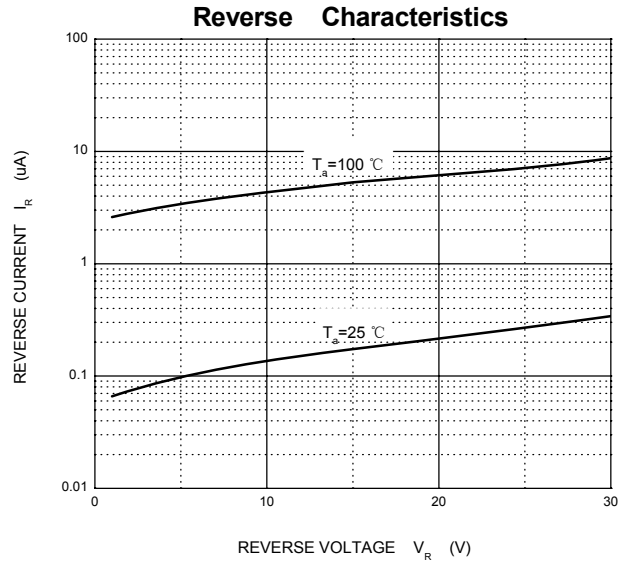
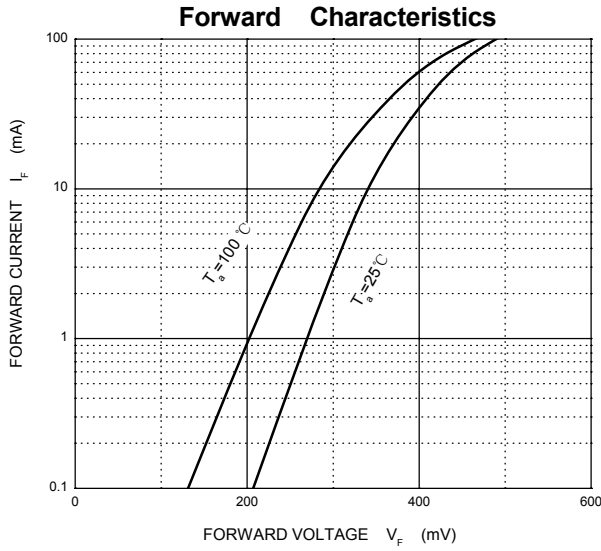

## SOT-523 Package Outline Dimensions

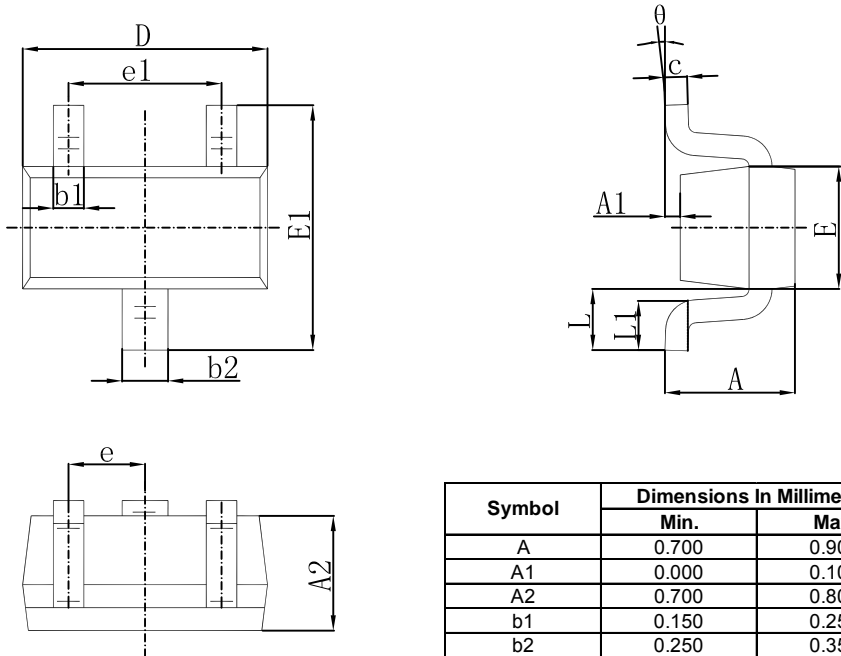

Symbol	Dimensions In Millimeters		Dimensions In Inches	
	Min.	Max.	Min.	Max.
A	0.700	0.900	0.028	0.035
A1	0.000	0.100	0.000	0.004
A2	0.700	0.800	0.028	0.031
b1	0.150	0.250	0.006	0.010
b2	0.250	0.350	0.010	0.014
c	0.100	0.200	0.004	0.008
D	1.500	1.700	0.059	0.067
E	0.700	0.900	0.028	0.035
E1	1.450	1.750	0.057	0.069
e	0.500 TYP.		0.020 TYP.	
e1	0.900	1.100	0.035	0.043
L	0.400 REF.		0.016 REF.	
L1	0.260	0.460	0.010	0.018
θ	0°	8°	0°	8°

## SOT-523 Suggested Pad Layout

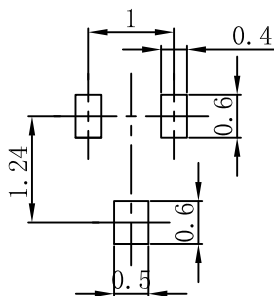

- Note:
1. Controlling dimension: in millimeters.
  2. General tolerance:  $\pm 0.05\text{mm}$ .
  3. The pad layout is for reference purposes only.