

### Features

- Dual rectifier construction, positive centetap, offer 10.0A Half wave and 20.0A full wave rectification.
- High surge current capability.
- Super fast recovery time for switching mode application.
- Low power loss.
- Glass passivated chip junctions.
- Lead-free parts meet environmental standards of MIL-STD-19500/228

### Mechanical data

- Epoxy : UL94-V0 rated flame retardant
- Case : JEDEC ITO-220AB molded plastic body over passivated chip
- Lead : Axial leads, solderable per MIL-STD-202, Method 208 guranteed
- Polarity: As marked
- Mounting Position : Any

### Package outline

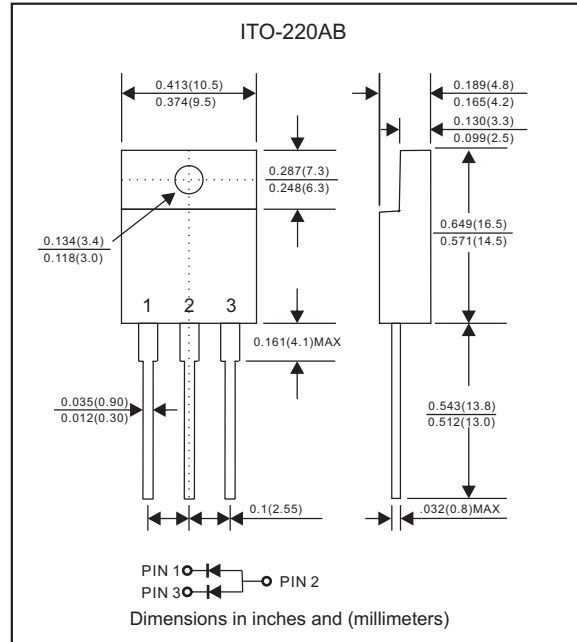

### Maximum ratings (AT $T_A=25^{\circ}\text{C}$ unless otherwise noted)

PARAMETER	SYMBOLS	MUR2020FCA	MUR2040FCA	MUR2060FCA	UNIT
Maximum repetitive peak reverse voltage	$V_{RRM}$	200	400	600	V
Maximum RMS voltage	$V_{RMS}$	140	280	420	V
Maximum DC blocking voltage	$V_{DC}$	200	400	600	V
Maximum average forward rectified current	$I_o$	20			A
Peak forward surge current 8.3ms single half sine-wave(JEDEC method)	$I_{FSM}$	125			A
Operating junction temperature range	$T_J$	-55 to +150			$^{\circ}\text{C}$
Storage temperature range	$T_{STG}$	-65 to +175			$^{\circ}\text{C}$

### Electrical Characteristics (AT $T_A=25^{\circ}\text{C}$ unless otherwise noted)

PARAMETER	SYMBOLS	MUR2020FCA	MUR2040FCA	MUR2060FCA	UNIT
Maximum forward voltage per leg at $I_F=10\text{A}$	$V_F$	0.98	1.30	1.70	V
Maximum reverse recovery time per leg (Note 1)	$t_{rr}$	25	50		ns
Maximum DC reverse current at $T_J=25^{\circ}\text{C}$ at rated DC blocking voltage per leg at $T_J=125^{\circ}\text{C}$	$I_R$	5.0 500			$\mu\text{A}$ $\mu\text{A}$

### Thermal Characteristics

PARAMETER	SYMBOLS	MUR2020FCA	MUR2040FCA	MUR2060FCA	UNIT
Typical thermal resistance junction to case per leg	$R_{\theta JC}$	2.0			$^{\circ}\text{C}/\text{W}$

Note 1: Reverse recovery time test condition,  $I_F=0.5\text{A}$ ,  $I_R=1.0\text{A}$ ,  $I_{RR}=0.25\text{A}$

# Rating and characteristic curves(MUR2020FCA THRU MUR2060FCA)

FIG.1-TYPICAL FORWARD CURRENT DERATING CURVE

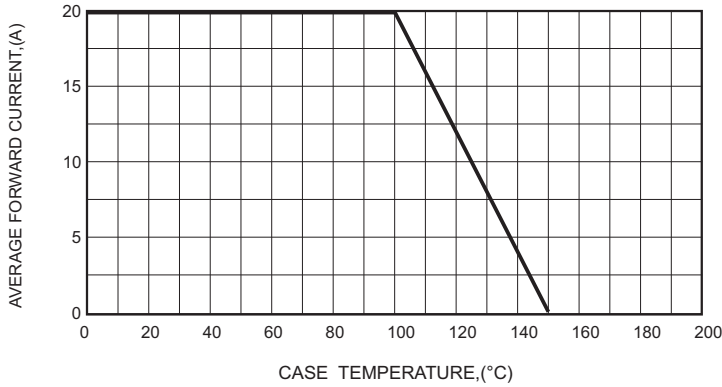

FIG.2-TYPICAL FORWARD CHARACTERISTICS

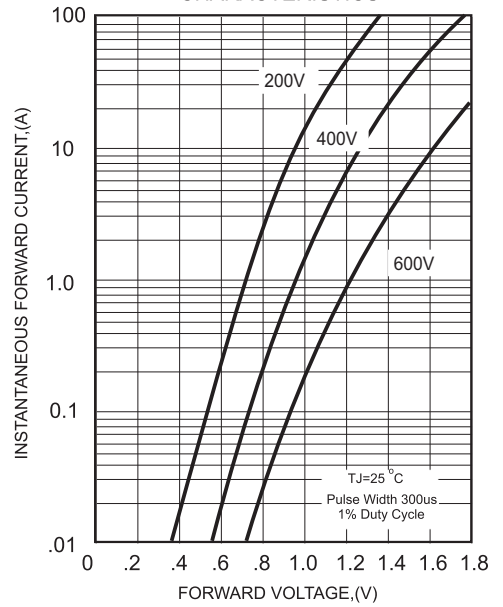

FIG.3-MAXIMUM NON-REPETITIVE FORWARD SURGE CURRENT

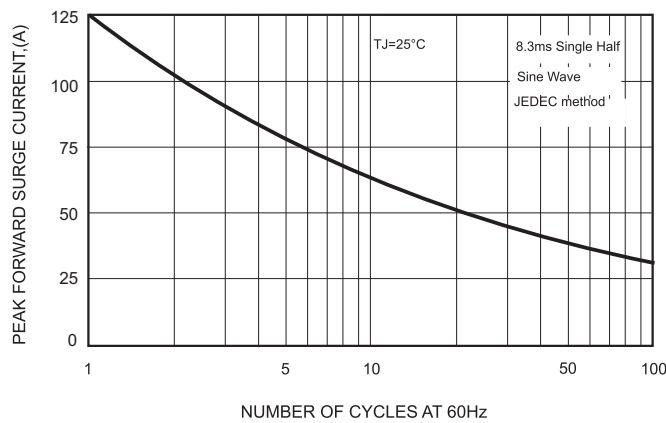

FIG.4 - TYPICAL REVERSE CHARACTERISTICS

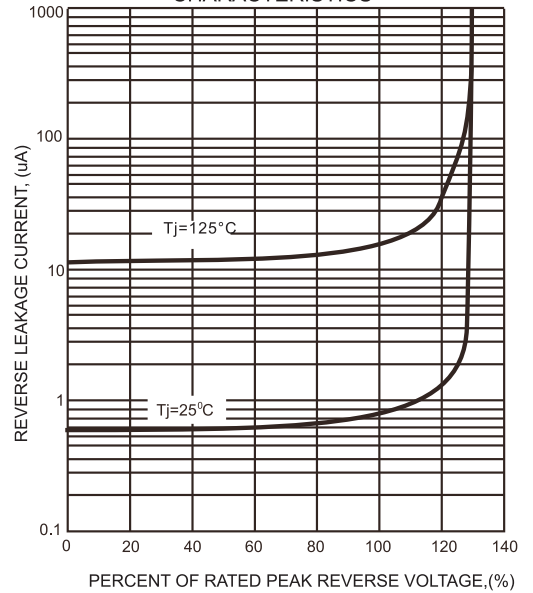
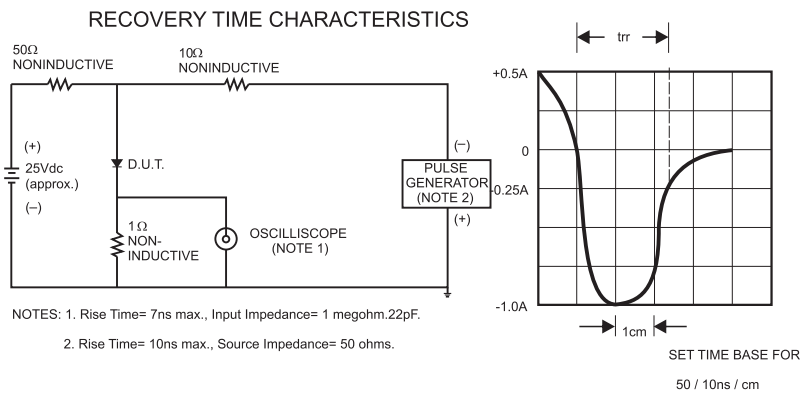

FIG.5- TEST CIRCUIT DIAGRAM AND REVERSE RECOVERY TIME CHARACTERISTICS



NOTES: 1. Rise Time= 7ns max., Input Impedance= 1 megohm, 22pF.  
2. Rise Time= 10ns max., Source Impedance= 50 ohms.

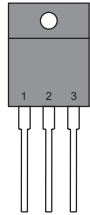
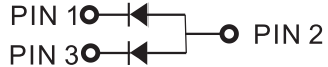

## Pinning information

Pin	Simplified outline	Symbol
Pin1 anode Pin2 cathode Pin3 anode		

## Marking

Type number	Marking code
MUR2020FCA	MUR2020FCA
MUR2040FCA	MUR2040FCA
MUR2060FCA	MUR2060FCA