

Features

- ▶ The plastic package carries Underwriters Laboratory Flammability Classification 94V-0
- ▶ Low reverse leakage
- ▶ High forward surge current capability
- ▶ High temperature soldering guaranteed: 250°C/10 seconds at terminals
- ▶ Glass passivated chip junction
- ▶ Compliant to RoHS Directive 2011/65/EU
- ▶ Compliant to Halogen-free

Mechanical data

- ▶ **Case:** TO-277B molded plastic body
- ▶ **Terminals:** Solder plated, solderable per MIL-STD-750, Method 2026
- ▶ **Polarity:** Polarity symbol marking on body
- ▶ **Mounting Position:** Any

Package outline

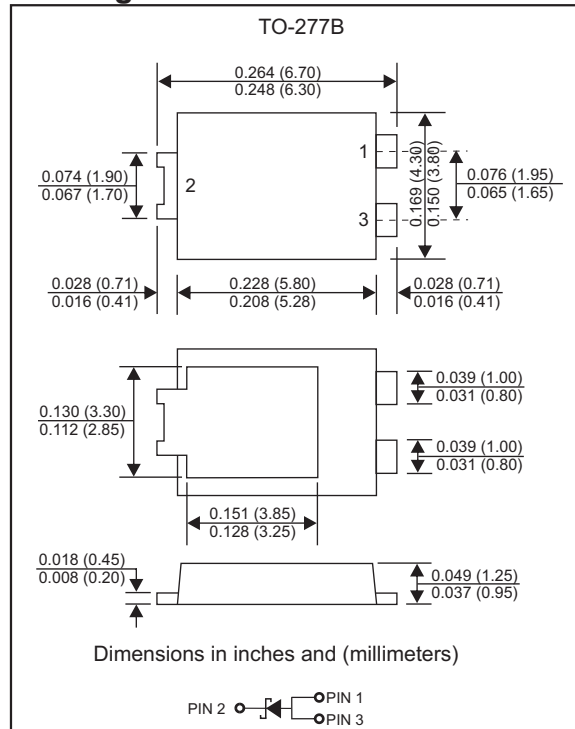

Maximum ratings and Electrical Characteristics (AT $T_A=25^\circ\text{C}$ unless otherwise noted)

PARAMETER	CONDITIONS	Symbol	MIN.	TYP.	MAX.	UNIT
Forward rectified current	$T_L = 100^\circ\text{C}$	I_O			10.0	A
Forward surge current	8.3ms single half sine-wave (JEDEC methode)	I_{FSM}			200	A
Reverse current	$V_R = V_{RRM}$ $T_J = 25^\circ\text{C}$	I_R			5.0	μA
	$V_R = V_{RRM}$ $T_J = 125^\circ\text{C}$				500	
Thermal resistance	Junction to ambient	$R_{\theta JA}$		60		$^\circ\text{C}/\text{W}$
Diode junction capacitance	f=1MHz and applied 4V DC reverse voltage	C_J		80		pF
Storage temperature		T_{STG}	-55		+150	$^\circ\text{C}$

SYMBOLS	V_{RRM}^{*1} (V)	V_{RMS}^{*2} (V)	V_R^{*3} (V)	V_F^{*4} (V)	Operating temperature T_J , ($^\circ\text{C}$)
S10A-T	50	35	50	1.10	-55 to +150
S10B-T	100	70	100		
S10D-T	200	140	200		
S10G-T	400	280	400		
S10J-T	600	420	600		
S10K-T	800	560	800		
S10M-T	1000	700	1000		

*1 Repetitive peak reverse voltage

*2 RMS voltage

*3 Continuous reverse voltage

*4 Maximum forward voltage@ $I_F=10.0\text{A}$

Rating and characteristic curves

FIG. 1- DERATING CURVE OUTPUT RECTIFIED CURRENT

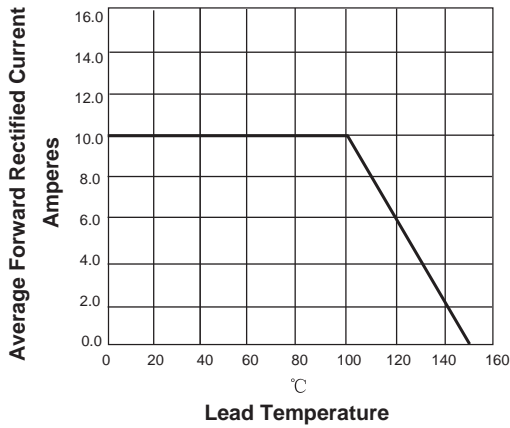

FIG. 2-MAXIMUM NON-REPETITIVE PEAK FORWARD SURGE CURRENT PER LEG

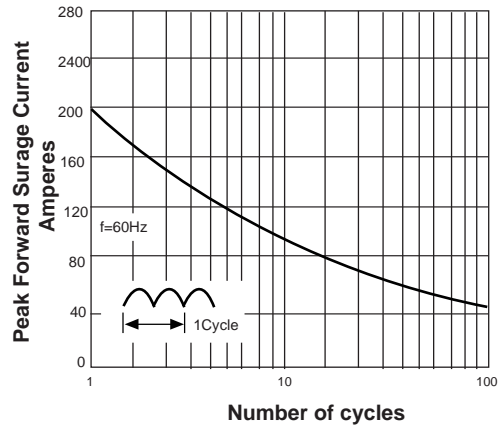

FIG. 3-TYPICAL FORWARD VOLTAGE CHARACTERISTICS

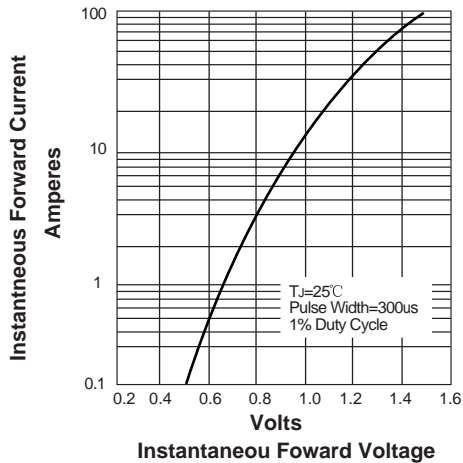
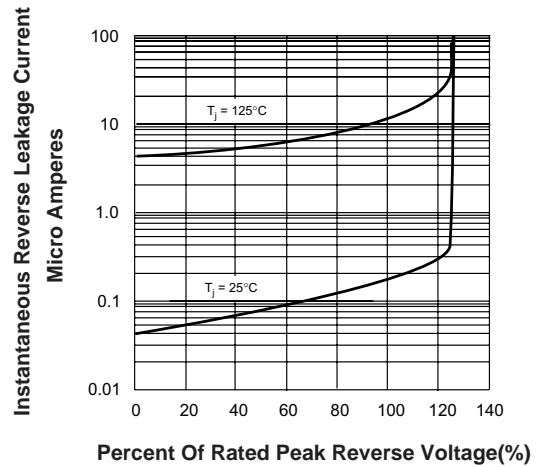

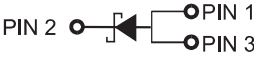

FIG. 4-TYPICAL REVERSE LEAKAGE CHARACTERISTICS



Pinning information

Pin	Simplified outline	Symbol
Pin2 cathode Pin1 anode Pin3 anode		

Marking

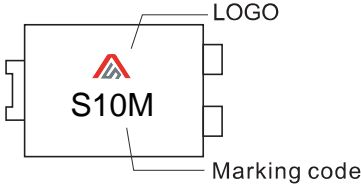
Type number	Marking code	Example
S10A-T	S10A	
S10B-T	S10B	
S10D-T	S10D	
S10G-T	S10G	
S10J-T	S10J	
S10K-T	S10K	
S10M-T	S10M	

Suggested solder pad layout

TO-277B

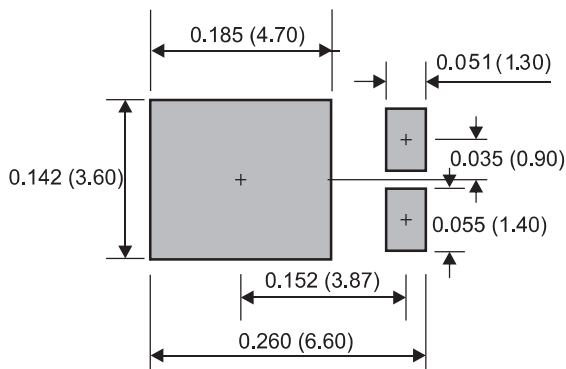

Dimensions in inches and (millimeters)