

Package outline

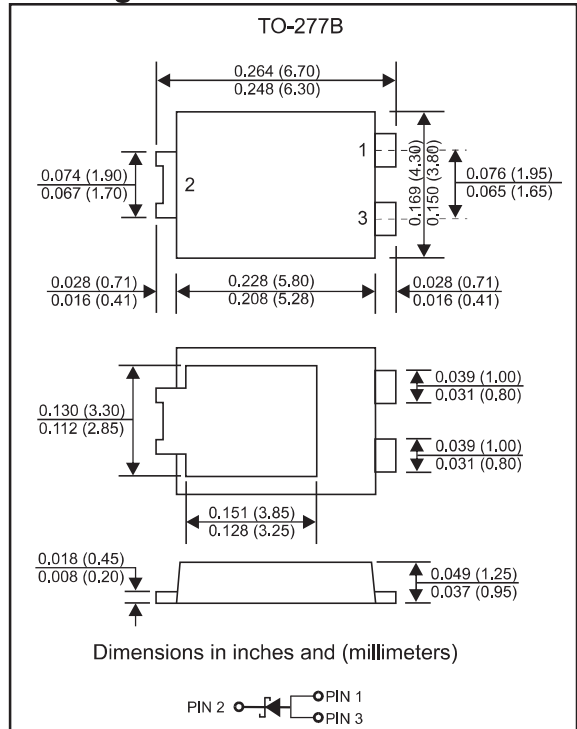

Features

- Ultra Low Forward Voltage Drop .
- Very low profile-typical height of 1.10mm
- Low Power Losses,High Efficiency Operation
- Low Thermal Resistance Package.
- High Operating Junction Temperature.
- Compliant to Halogen-free.
- Suffix "-Q1" for AEC-Q101

Mechanical data

- Epoxy:UL94-V0 rated flame retardant
- Case : TO-277B ,molded Plastic
- Terminals:Solderable per MIL-STD-750,Method 2026
- Marking:SL1545

Maximum ratings (AT $T_A=25^{\circ}\text{C}$ unless otherwise noted)

Parameter	Symbol	SL1545-T-Q1	Unit
DC Blocking Voltage Working Peak Reverse Voltage Repetitive Peak Reverse Voltage	V_{DC} V_{RWM} V_{RRM}	45.0	V
RMS Reverse Voltage	V_{RMS}	31.5	V
Average Forward Rectified Current	$I_{F(AV)}$	15.0	A
Peak Forward Surge Current,8.3ms Half Sine-wave($T_A=25^{\circ}\text{C}$)	I_{FSM}	250	A
Operating junction temperature range	T_J	-55 to +150	$^{\circ}\text{C}$
Storage temperature range	T_{STG}	-55 to +150	$^{\circ}\text{C}$

Electrical Characteristics (AT $T_A=25^{\circ}\text{C}$ unless otherwise noted)

Parameter	Test Conditions	Symbol	MIN.	TYP.	MAX.	Unit
Reverse Breakdown Voltage	$I_R=0.5\text{mA}, T_J=25^{\circ}\text{C}$	V_B	45	-	-	V
Forward voltage	$I_F=15\text{A}, T_J=25^{\circ}\text{C}$	V_F	-	0.48	0.50	V
Reverse current	$V_R=45\text{V}, T_J=25^{\circ}\text{C}$	I_R	-	-	0.5	mA
	$V_R=45\text{V}, T_J=100^{\circ}\text{C}$		-	-	50	

Thermal Characteristics



Parameter	Symbol	SL1545-T-Q1	Unit
Typical thermal resistance junction to ambient (Note 1)	$R_{\theta JA}$	110	$^{\circ}\text{C}/\text{W}$
Typical thermal resistance junction to case (Note 1)	$R_{\theta JC}$	25	$^{\circ}\text{C}/\text{W}$

Note 1: Mounted on FR-4 PCB copper pad area. Cathode pad dimensions 4.95mm x 3.4mm.
Anode pad dimensions 1.55mm x 5.0mm.

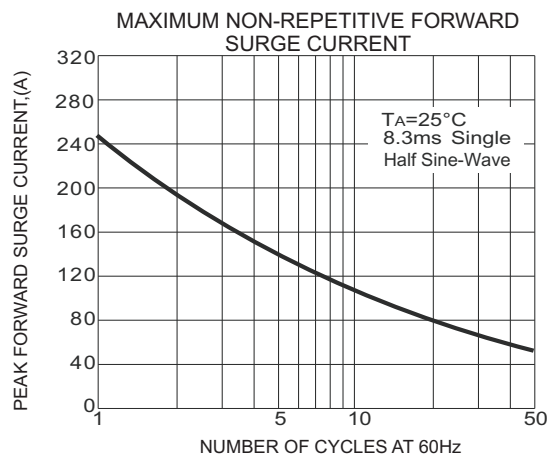
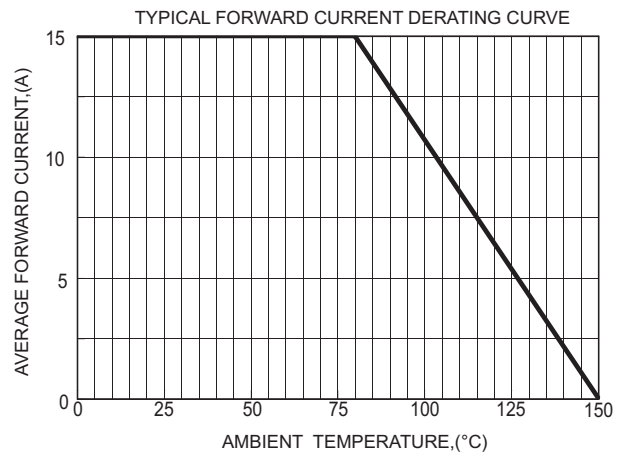
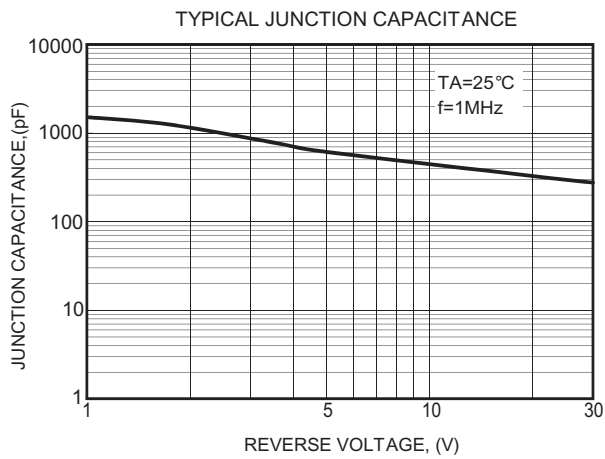
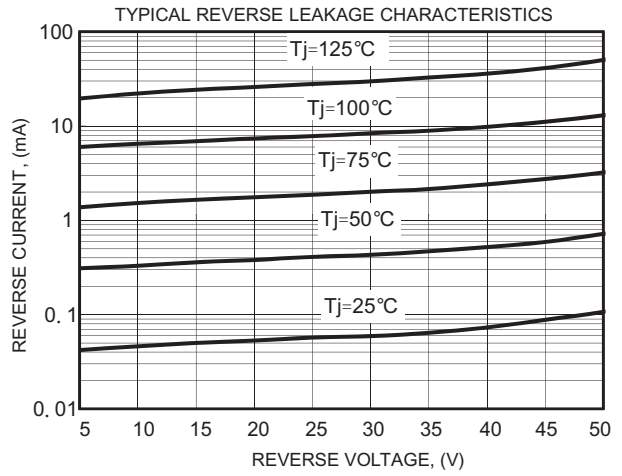
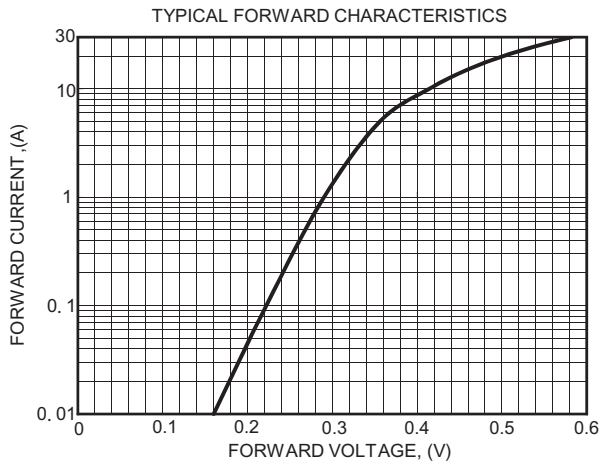
Rating and characteristic curves



Pinning information

Pin	Simplified outline	Symbol
Pin2 cathode Pin1 anode Pin3 anode		

Marking

Type number	Marking code
SL1545-T-Q1	SL1545

Suggested solder pad layout

TO-277B

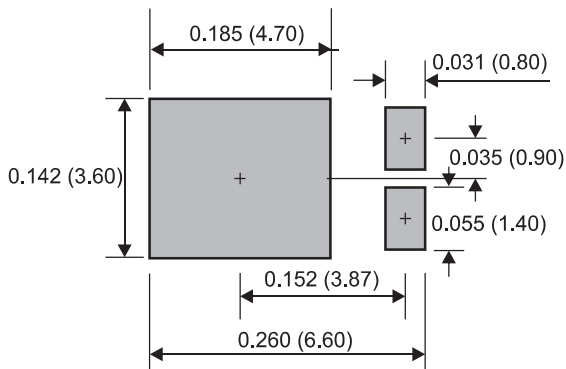

Dimensions in inches and (millimeters)